

RFQ Pricing

COMMERCIAL FOOD SYSTEMS, INC.

No Contracts. No Minimums. No Delivery Charges. No Fuel Charges.



SPARKLING ICE.



ZEE ZEE'S



Campbell's



To insure the most up to date nutritional and allergen information, please contact the manufacturer in question directly. Our peanut free symbol means the manufacturer's ingredient list does not contain peanuts and the manufacturer has issued a peanut free facility statement.

























The nutrition information provided in this brochure reflects the current information provided to Commercial Foods by its suppliers. Prior to consuming the product, individuals with severe food allergies should confirm ingredient information on the actual label of the product.

Allow Commercial Food Systems to be the supplier who sources new products for you. Just ask us!
Tony Gates | Chris Hutton | Beth Schave | Shannon Walls

Tel: 317.926.4237 Toll Free: 800.283.7437 Fax: 317.924.3086
2210 Enterprise Park Place Indianapolis, IN 46218
Order online at: www.commercialfoodsystems.com

ISNA Industry Partner - Indiana Owned & Operated est. 1984

New Items denoted by Bold Red Font on the following pages.

| | | | | |
|--|---|-------------|---------|---|
| Bum Energy | | | | |
|  | 15096 Blue Snow Cone | 12 / 12 oz | | H 18+ |
| | 17529 Root Beer | 12 / 12 oz | | H 18+ |
| | 79015 Pink Lemonade | 12 / 12 oz | | H 18+ |
| | 79038 Dr. Bum | 12 / 12 oz | | H 18+ |
| | 92091 Watermelon | 12 / 12 oz | | H 18+ |
| Campbell's | | | | |
|  | 05684 Whole Grain Sour Cream & Onion Goldfish | 300 / .75 c | SB |  |
| Dole | | | | |
|  | 00419 Pineapple Cup | 36 / 4 oz | SF |  |
| Frito Lay | | | | |
|  | 80488 Munchies Snack Mix | 104 / .87 c | SB |  |
| | 80697 Spicy Sweet Chili Walking Taco | 44 / 1.4 oz | E2B |  |
| General Mills - Small Bowl Packs | | | | |
|  | 11768 Reduced Sugar Frosted Flakes | 96 / 1 oz | SB |  |
| General Mills - Large Bowl Packs | | | | |
|  | 23565 Reduced Sugar Frosted Flakes | 60 / 2 oz | E2B |  |
| Kelloggs - Small Bowl Packs | | | | |
|  | 11496 Cocoa Loops | 96 / 1 oz | SB |  |
| Kelloggs - Cereal Pouches | | | | |
|  | 11322 Cocoa Loops | 60 / 2 oz | E2B |  |
| | 71170 Kashi Maple Waffle Bites | 96 / 1 oz | SB |  |
| MJM | | | | |
|  | 524150 Dino Bites - Vanilla | 150 / 1 oz | SB |  |
| | 4155 Savory Bites - Pizza | 155 / .8 oz | SB |  |
| Old Wisconsin | | | | |
|  | 12955 Turkey Stick | 144 / .6 oz | S 1/2 P |  |
| Ocean Spray | | | | |
|  | 01494 Craisins - Fruit Punch | 200 / 1.16 | SF |  |
| Peterson Farms Juice Pouch - 4 oz | | | | |
|  | 10113 Apple Juice Pouch | 96 / 4 oz | | A |
| | 10115 Fruit Punch Pouch | 96 / 4 oz | | A |
| | 10121 Berry Blend Pouch | 96 / 4 oz | | A |
| | 10139 Sunrise Blend Pouch | 96 / 4 oz | | A |
| | 10142 Lemonade Pouch | 96 / 4 oz | | A |
| Peterson Farms Juice Pouch - 6 oz | | | | |
|  | 10125 Apple Juice Pouch | 88 / 6 oz | | A |
| | 10127 Berry Blend Pouch | 88 / 6 oz | | A |
| | 10129 Fruit Punch Pouch | 88 / 6 oz | | A |
| | 10140 Sunrise Blend Pouch | 88 / 6 oz | | A |
| | 10143 Lemonade Pouch | 88 / 6 oz | | A |
| PepsiCo - Propel | | | | |
|  | 135391 Propel Variety Pack Cape/Kiwi Strawberry/Berry | 24 / 16.9 c | | H |
| Sparkling Ice | | | | |
|  | 96230 Wild Cherry Lifesavers | 12 / 17 oz | | H |
| | 96232 Pineapple Lifesavers | 12 / 17 oz | | H |
| | 96236 Strawberry Lifesavers | 12 / 17 oz | | H |
| Sparkling Ice + Caffeine | | | | |
|  | 4934 Orange Cream | 12 / 16 oz | | H |
| Zee Zee's | | | | |
|  | 621354 Sour Strawberry Raisins | 120 / 1.45 | SF |  |
| | 621355 Sour Raspberry Raisins | 120 / 1.45 | SF |  |
| Uptime Energy | | | | |
|  | 91972 Original Citrus | 12 / 12 oz | | H |
| | 91992 Blood Orange | 12 / 12 oz | | H |
| | 92172 Blueberry Pomegranate | 12 / 12 oz | | H |

Icons for Water, Juice, & Other Beverages

A Compliant for Elementary, Middle, & High Schools

M Compliant for Middle & High Schools, **NOT** Elementary Schools

H Compliant for **HIGH SCHOOLS ONLY!**

NOT Recommended for persons **18+** 18 years and younger!

Icons for Food Items

S Meets the USDA Smart Snacks In School Guidelines!

E Item is eligible for menuing as long as all meal requirements are met.

B (Grains/Breads) **F** (Fruits) **D** (Dairy) **P** (Proteins) **V** (Vegetables)
Items contribute to the USDA Food Buying Guide for Child Nutrition Programs





Water, Juice, & Other Beverages

A Compliant for Elementary, Middle, & High Schools **M** Compliant for Middle & High Schools, **NOT** Compliant for **Elementary Schools** **H** Compliant for **HIGH SCHOOLS ONLY!** **18+** NOT Recommended for persons **18 years and younger!**



Arizona Tea

73049 Arnold Palmer Zero 12 / 11.5 oz **H**



Bum Energy

15096 **Blue Snow Cone** 12 / 12 oz **H** 18+
 17529 **Root Beer** 12 / 12 oz **H** 18+
 79015 **Pink Lemonade** 12 / 12 oz **H** 18+
 79038 **Dr. Bum** 12 / 12 oz **H** 18+
 92091 **Watermelon** 12 / 12 oz **H** 18+



Ice Mountain Natural Spring Water

7091 8 oz Bottle 48 / 8 oz **A**
 7093 16.9 oz Bottle 40 / 16.9 oz **A**



IZZE

01146 Sparkling Strawberry 24 / 8.4 oz **M**
 15023 Sparkling Blackberry 24 / 8.4 oz **M**
 15054 Sparkling Clementine 24 / 8.4 oz **M**
 15078 Sparkling Apple 24 / 8.4 oz **M**



Heartland Coffee

309322 Java House Coffee **Case Yield: 960 ounces**
Approximately 120 - 8 oz servings 6 / 32 oz **H**



Frazil

22014 Blue Razzmatazz **Must buy 20 case minimum per school year to get equipment.** 144 / 8 oz **A**
 22021 Strawberry Ice **Case Yield: 1152 ounces** 144 / 8 oz **A**
 22083 Triple Berry **Case=Six 32 oz Bottles** 144 / 8 oz **A**
Approximately 144 8 - 8oz servings



Juicy Juice - 100% Juice 4.23oz

00147 Juicy Juice - Kiwi Strawberry 40 / 4.23 oz **A**
 14523 Juicy Juice - Apple 40 / 4.23 oz **A**
 25216 Juicy Juice - Fruit Punch 40 / 4.23 oz **A**
 52179 Juicy Juice - Orange Tangerine 40 / 4.23 oz **A**
 88579 Juicy Juice - Berry 40 / 4.23 oz **A**
 88977 Juicy Juice - Grape 40 / 4.23 oz **A**



Juicy Juice - 100% Juice 6.75oz

15794 Juicy Juice - Apple 32 / 6.75 oz **A**
 15896 Juicy Juice - Kiwi Strawberry 32 / 6.75 oz **A**
 52479 Juicy Juice - Grape 32 / 6.75 oz **A**
 79564 Juicy Juice - Fruit Punch 32 / 6.75 oz **A**
 84125 Juicy Juice - Orange Tangerine 32 / 6.75 oz **A**
 87776 Juicy Juice - Berry 32 / 6.75 oz **A**



Juicy Juice - 100% Juice 10oz Bottle

00011 Juicy Juice - Apple 24 / 10 oz **M**
 00014 Juicy Juice - Fruit Punch 24 / 10 oz **M**
 00080 Juicy Juice - Grape 24 / 10 oz **M**
 00094 Juicy Juice - Orange Tangerine 24 / 10 oz **M**



Juicy Juice - 100% Veggie & Fruit Juic

00066 Veggie & Fruit Orange Medley - 4.23 oz **Meets Orange Vegetables** 40 / 4.23 oz **A**
 00146 Rainbow Punch 32 / 6.75 oz **A**



Kikkoman Pearl Soy Milk - Organic

60085 Chocolate 24 / 8.25 oz **A**
 60087 Vanilla 24 / 8.25 oz **A**



Milk - Shelf Stable

0113 Fat Free Chocolate 27 / 8 oz **A**
 4672 1% White 27 / 8 oz **A**



Nature's Twist

91756 Lemonade Variety Pack - Lemonade/Straw berry Lemonade 24 / 16.9 oz **H**

Water, Juice, & Other Beverages



PepsiCo

| | | | |
|---------------|--|---------------------|----------|
| 135391 | Propel Variety Pack - Grape/Kiwi Strawberry/Berry | 24 / 16.9 oz | H |
| 159301 | Life WTR | 12 / 24 oz | A |
| 121347 | Pepsi Zero | 24 / 16.9 oz | H |
| 192475 | Mt. Dew Zero | 24 / 16.9 oz | H |
| 198561 | Dr. Pepper Zero | 24 / 16.9 oz | H |
| 325576 | Wild Cherry Pepsi Zero | 24 / 16.9 oz | H |



Peterson Farms Juice Pouch - 4 oz

| | | | |
|--------------|----------------------------|------------------|----------|
| 10113 | Apple Juice Pouch | 96 / 4 oz | A |
| 10115 | Fruit Punch Pouch | 96 / 4 oz | A |
| 10121 | Berry Blend Pouch | 96 / 4 oz | A |
| 10139 | Sunrise Blend Pouch | 96 / 4 oz | A |
| 10142 | Lemonade Pouch | 96 / 4 oz | A |



Peterson Farms Juice Pouch - 6 oz

| | | | |
|--------------|----------------------------|------------------|----------|
| 10125 | Apple Juice Pouch | 88 / 6 oz | A |
| 10127 | Berry Blend Pouch | 88 / 6 oz | A |
| 10129 | Fruit Punch Pouch | 88 / 6 oz | A |
| 10140 | Sunrise Blend Pouch | 88 / 6 oz | A |
| 10143 | Lemonade Pouch | 88 / 6 oz | A |



Peterson Farms - Cool Tropics Slush Pouch - 4 oz

| | | | |
|--------------|----------------------------|------------------|----------|
| 12002 | Apple Juice Pouch | 96 / 4 oz | A |
| 12004 | Berry Blend Pouch | 96 / 4 oz | A |
| 13001 | Fruit Punch Pouch | 96 / 4 oz | A |
| 31776 | Sunrise Blend Pouch | 96 / 4 oz | A |



Popwell Soda

| | | | |
|-------|-----------------|------------|---|
| 95968 | Cherry Citrus | 12 / 12 oz | H |
| 95970 | Blackberry Lime | 12 / 12 oz | H |
| 96059 | Orange Cream | 12 / 12 oz | H |



Quaker - Gatorade Zero

| | | | |
|-------|-----------------------------------|------------|---|
| 04212 | Gatorade Zero - Lemon Lime | 24 / 20 oz | H |
| 04214 | Gatorade Zero - Glacier Cherry | 24 / 20 oz | H |
| 04318 | Gatorade Zero - Orange | 24 / 20 oz | H |
| 04354 | Gatorade Zero - Glacier Freeze | 24 / 20 oz | H |
| 04706 | Gatorade Zero - Cool Blue | 24 / 20 oz | H |
| 04338 | Gatorade Zero - Orange | 24 / 12 oz | H |
| 04339 | Gatorade Zero - Glacier Cherry | 24 / 12 oz | H |
| 04342 | Gatorade Zero - Glacier Freeze | 24 / 12 oz | H |
| 04710 | Gatorade Zero - Cool Blue | 24 / 12 oz | H |
| 05504 | Gatorade Zero - Watermelon Splash | 24 / 12 oz | H |



Sparkling Ice

| | | | |
|--------------|-------------------------------|-------------------|----------|
| 91030 | Black Raspberry | 12 / 17 oz | H |
| 91031 | Orange Mango | 12 / 17 oz | H |
| 91032 | Kiwi Strawberry | 12 / 17 oz | H |
| 91035 | Lemonade | 12 / 17 oz | H |
| 94033 | Coconut Pineapple | 12 / 17 oz | H |
| 95029 | Strawberry Lemonade | 12 / 17 oz | H |
| 95084 | Cherry Limeade | 12 / 17 oz | H |
| 95087 | Strawberry Watermelon | 12 / 17 oz | H |
| 95211 | Black Cherry | 12 / 17 oz | H |
| 95268 | Grape Raspberry | 12 / 17 oz | H |
| 96230 | Wild Cherry Lifesavers | 12 / 17 oz | H |
| 96232 | Pineapple Lifesavers | 12 / 17 oz | H |
| 96236 | Strawberry Lifesavers | 12 / 17 oz | H |

Water, Juice, & Other Beverages

Sparkling Ice + Caffeine

| | | | | |
|--|-------------|---------------------|-------------------|----------|
|  | 1905 | Strawberry Citrus | 12 / 16 oz | H |
| | 1982 | Black Raspberry | 12 / 16 oz | H |
| | 1983 | Blue Raspberry | 12 / 16 oz | H |
|  | 1984 | Citrus Twist | 12 / 16 oz | H |
| | 2838 | Tropical Punch | 12 / 16 oz | H |
| | 4934 | Orange Cream | 12 / 16 oz | H |

Tasty Brands

| | | | | |
|--|-------|--------------------------------------|-----------|---|
|  | 68003 | Perk Cold Brew Coffee Milk - Vanilla | 24 / 8 oz | H |
|--|-------|--------------------------------------|-----------|---|

The Switch - 100% Juice with Carbonation

| | | | | |
|--|-----|-----------------------|-----------|---|
|  | 312 | Black Cherry | 24 / 8 oz | A |
| | 314 | Orange Tangerine | 24 / 8 oz | A |
|  | 315 | Fruit Punch | 24 / 8 oz | A |
| | 316 | Watermelon Strawberry | 24 / 8 oz | A |
| | 337 | Kiwi Berry | 24 / 8 oz | A |

Uptime Energy

| | | | | |
|--|--------------|------------------------------|-------------------|----------|
|  | 91972 | Original Citrus | 12 / 12 oz | H |
| | 91992 | Blood Orange | 12 / 12 oz | H |
| | 92172 | Blueberry Pomegranate | 12 / 12 oz | H |

Yoo-Hoo

| | | | | |
|--|-------|-----------------|------------|--|
|  | 28097 | Chocolate Drink | 24 / 11 oz | |
|--|-------|-----------------|------------|--|

Breakfast Kits

just add a **2nd fruit/vegetable** & **milk**
for a complete reimbursable USDA breakfast!

Breakfast On The Go ≡ (Developed for Breakfast in the Classroom)

| | | | | |
|--|-------|---|-------|-------------|
|  | 40013 | Whole Grain Single Cinnamon Pop Tart 1 GB Whole Grain Snack 4.23 oz 100% Grape Juice | 24 ct | S2B/F 🍌 🍌 🍌 |
| | 40014 | Whole Grain Single Strawberry Pop Tart 1 GB Whole Grain Snack 4.23 oz 100% Berry Juice | 24 ct | S2B/F 🍌 🍌 🍌 |
| | 40017 | Kellogg's Kashi Pouch Cereal - Variety 1 GB Whole Grain Snack 4.23 oz 100% Orange-Tangerine Juice | 24 ct | S2B/F 🍌 🍌 🍌 |
| | 40018 | Whole Grain Single Fudge Pop Tart 1 GB Whole Grain Snack 4.23 oz 100% Grape Juice | 24 ct | S2B/F 🍌 🍌 🍌 |

Breakfast On The Go ≡

| | | | | |
|--|-------|--|-------|-------------|
|  | 40001 | Cinnamon Toasters™ cereal bowl 1 GB Whole Grain Snack 4.23 oz 100% Apple Juice | 24 ct | S2B/F 🍌 🍌 🍌 |
| | 40004 | General Mills Reese Puffs cereal bowl 1 GB Whole Grain Snack 4.23 oz 100% Orange-Tangerine Juice | 24 ct | S2B/F 🍌 🍌 🍌 |
| | 40005 | General Mills Cocoa Puffs cereal bowl 1 GB Whole Grain Snack 4.23 oz 100% Orange-Tangerine Juice | 24 ct | S2B/F 🍌 🍌 🍌 |
| | 40008 | Marshmallow Matey's® cereal bowl 1 GB Whole Grain Snack 4.23 oz 100% Fruit Punch Juice | 24 ct | S2B/F 🍌 🍌 🍌 |
| | 40009 | General Mills Trix cereal bowl 1 GB Whole Grain Snack 4.23 oz 100% Berry Juice | 24 ct | S2B/F 🍌 🍌 🍌 |

Breakfast Cereals - Bowl Packs

Malt-O-Meal / Post - Small Bowls



| | | | | |
|-------|---|-------------|------|--|
| 542 | Crispy Rice / Kellogg's Rice Krispies® - LOW SUGAR | 96 / .63 oz | 1/2B | |
| 1015 | Frosted Flakes / Kellogg's® Frosted Flakes | 96 / 1 oz | B | |
| 1315 | Tootie Fruities® / Kellogg's Froot Loops® | 96 / .75 oz | 3/4B | |
| 1515 | Coco-Roos® / GM Cocoa Puffs® | 96 / .87 oz | 3/4B | |
| 2415 | Berry Colossal Crunch® / Cap'n Crunch Berries | 96 / 1 oz | B | |
| 3915 | Cinnamon Toasters™ / GM Cinnamon Toast Crunch® | 96 / 1 oz | SB | |
| 4515 | Honey Graham Toasters™ / GM Golden Grahams® | 96 / 1 oz | B | |
| 27164 | Scooters / GM Cherrios® - LOW SUGAR | 96 / 1 oz | SB | |
| 27596 | Marshmallow Matey's® - LOW SUGAR | 96 / 1 oz | SB | |
| 27597 | Honey Scooters® - LOW SUGAR | 96 / 1 oz | SB | |
| 29594 | Fruity Pebbles | 96 / 1 oz | B | |

General Mills - Small Bowl Packs



| | | | | |
|--------------|--|------------------|-----------|--|
| 11768 | Reduced Sugar Frosted Flakes | 96 / 1 oz | SB | |
| 11943 | Golden Grahams - LOW SUGAR | 96 / 1 oz | EB | |
| 18446 | Blueberry Chex - LOW SUGAR | 96 / 1 oz | SB | |
| 18447 | Honey Cheerios- LOW SUGAR | 96 / 1 oz | SB | |
| 22488 | Reduced Sugar Lucky Charms - LOW SUGAR | 96 / 1 oz | EB | |
| 29444 | Reduced Sugar Cinnamon Toast Crunch - LOW SUGAR | 96 / 1 oz | SB | |
| 31919 | Reese Puffs | 96 / 1 oz | SB | |
| 31888 | Reduced Sugar Cocoa Puffs - LOW SUGAR | 96 / 1.06 oz | SB | |
| 31921 | Rice Chex - LOW SUGAR | 96 / 1 oz | EB | |
| 31922 | Reduced Sugar Trix - LOW SUGAR | 96 / 1 oz | SB | |
| 32262 | Cheerios - LOW SUGAR | 96 / 1 oz | SB | |
| 38387 | Cinnamon Chex - LOW SUGAR | 96 / 1 oz | SB | |



Kelloggs - Small Bowl Packs

| | | | | |
|--------------|--------------------|------------------|-----------|--|
| 11496 | Cocoa Loops | 96 / 1 oz | SB | |
|--------------|--------------------|------------------|-----------|--|

Malt-O-Meal / Post - Large Bowls (Faster Breakfast Service with 2 Breads in 1 Bowl!)



| | | | | |
|-------|---|-----------|----|--|
| 8676 | Honey Scooters® - LOW SUGAR | 48 / 2 oz | 2B | |
| 00955 | Frosted Flakes / Kellogg's® Frosted Flakes | 48 / 2 oz | 2B | |
| 03759 | Honey Graham Toasters™ / GM Golden Grahams® | 48 / 2 oz | 2B | |
| 05940 | Marshmallow Matey's® / GM Lucky Charms® | 48 / 2 oz | 2B | |
| 13820 | Cinnamon Toasters™ - LOW SUGAR | 48 / 2 oz | 2B | |

General Mills - Large Bowl Packs



| | | | | |
|--------------|--|------------------|------------|--|
| 14883 | Cinnamon Chex - LOW SUGAR | 60 / 2 oz | E2B | |
| 14885 | Reduced Sugar Cocoa Puffs - LOW SUGAR | 60 / 2 oz | E2B | |
| 14886 | Reduced Sugar Cinnamon Toast Crunch - LOW SUGAR | 60 / 2 oz | E2B | |
| 17262 | Blueberry Chex - LOW SUGAR | 60 / 2 oz | E2B | |
| 18448 | Honey Cheerios - LOW SUGAR | 60 / 2 oz | E2B | |
| 19567 | Reduced Sugar Trix - LOW SUGAR | 60 / 2 oz | E2B | |
| 22489 | Lucky Charms - LOW SUGAR | 60 / 2 oz | E2B | |
| 23565 | Reduced Sugar Frosted Flakes | 60 / 2 oz | E2B | |

***LOW SUGAR - cereal contains 6g of sugar or less**

Breakfast Cereals - Pouches & Bulk



Kellogg's - Cereal Pouches

- 11322 **Cocoa Loops**
- 11618 Kashi Strawberry Banana Smoothie Loops
- 71170 **Kashi Maple Waffle Bites**

60 / 2 oz
96 / 1 oz
96 / 1 oz

E2B
SB
SB



Bulk Cereal - Kellogg's

- 49834 Granola Crunch Clusters

4 / 50 oz

S ¹³%B

Fruits

Apple Sauce Cups - Cherry Central



- 9116 Apple Sauce - Plain
- 9118 Apple Sauce - Strawberry
- 9119 Apple Sauce - Cinnamon
- 9700 Apple Sauce - Blue Raspberry

96 / 4.5 oz
96 / 4.5 oz
96 / 4.5 oz
96 / 4.5 oz

S F
S F
S F
S F

Cherry Central



- 02136 Dried Cherries
- 49602 Sour Berries

100 / 1.36 oz
100 / 1.27 oz

S F
S F

Dole



- 03352 Wiggles - Orange
- 03353 Wiggles - Strawberry
- 03354 Wiggles - Cherry
- 00419 **Pineapple Cup**

36 / 4.3 oz
36 / 4.3 oz
36 / 4.3 oz
36 / 4 oz

S F
S F
S F
S F

Fruit Cups (Seasonally Available) - NO SUGAR ADDED



- 7602 Peach Fruit Cups
- 7603 Mandarin Orange Fruit Cups
- 7604 Mixed Fruit Cups
- 7605 Diced Pear Fruit Cups

96 / 4.5 oz
96 / 4.5 oz
96 / 4.5 oz
96 / 4.5 oz

S F
S F
S F
S F

Ocean Spray



- 01491 Lower Sugar Craisins - Cherry
- 01492 Lower Sugar Craisins - Strawberry
- 01493 Lower Sugar Craisins - Watermelon
- 01494 **Lower Sugar Craisins - Fruit Punch**

200 / 1.16 oz
200 / 1.16 oz
200 / 1.16 oz
200 / 1.16 oz

S F
S F
S F
S F

Raisels



- 10569 Tropical Fruit Raisels - NO SUGAR ADDED
- 10570 Grape Raisels - NO SUGAR ADDED

200 / 1.35 oz
200 / 1.35 oz

S F
S F

Tree Top



- 105260 Apple Crisps - Strawberry
- 105261 Apple Crisps - Plain

125 / .34 oz
125 / .34 oz

S F
S F

Zee Zee's



- 620935 Mixzees Dried Fruit
- 621169 Raisins
- 621354 **Sour Strawberry Raisins**
- 621355 **Sour Raspberry Raisins**

120 / 1.33 oz
120 / 1.33 oz
120 / 1.45 oz
120 / 1.45 oz

S F
S F
S F
S F

S Meets the USDA Smart Snacks In School Guidelines!

E Item is eligible for menuing as long as all meal requirements are met.

Icons for Food Items

B (Grains/Breads) **F** (Fruits) **D** (Dairy)
P (Proteins) **V** (Vegetables)
Items contribute to the USDA Food Buying Guide for Child Nutrition Programs



Components & Condiments



Backpack Yogurt

| | | | |
|--------|------------------------------------|-----------|-------------------|
| 782953 | Shelf Stable Yogurt - Summer Berry | 48 / 4 oz | S P |
| 72953 | Shelf Stable Yogurt - Strawberry | 48 / 4 oz | S P |



Butter Buds

| | | | |
|-------|-------------------------|-----------|----------|
| 49835 | Butter Buds | 24 / 4 oz | E |
| 56217 | Buttermist Spray | 6 / 17 oz | E |
| 56367 | Garlic Buttermist Spray | 6 / 17 oz | E |



DYMA Brands

| | | | |
|-------|----------------------------------|---------------|-------------------|
| 73014 | Low Sodium Light Ranch Pouch | 200 / 12 gr | E |
| 77002 | BBQ Cup | 100 / 1 oz | E |
| 77004 | Buffalo Ranch Dipping Sauce | 100 / 1 oz | E |
| 77005 | Dynamite Sauce | 100 / 1 oz | E |
| 77007 | Honey Mustard Cup | 100 / 1 oz | E |
| 77013 | Low Sodium Ranch Cup | 100 / 1 oz | E |
| 77014 | Ranch Cup | 100 / 1 oz | E |
| 85837 | Chick n Dippin Sauce | 100 / 1 oz | E |
| 86420 | Peanut Butter & Grape Jelly Pack | 200 / 2.12 oz | E P |



Jack Links

| | | | |
|------|------------------------------|-------------|--------------------|
| 7717 | Jacks Links Jerky - Teriyaki | 48 / .85 oz | S %P |
| 7721 | Jacks Links Jerky - Original | 48 / .85 oz | S %P |



Old Wisconsin

| | | | |
|--------------|---------------------|--------------------|----------------------|
| 12948 | Beef Stick | 144 / .5 oz | S 1/2P |
| 12955 | Turkey Stick | 144 / .6 oz | S 1/2P |



Perfect Servings

| | | | |
|-------|---------------------------------------|---------------|----------|
| 15075 | Fast & Easy Microwavable Mac & Cheese | 100 / 2.15 oz | E |
|-------|---------------------------------------|---------------|----------|



Kaiser Pickles

| | | | |
|-------|---|-----------|----------|
| 80021 | Dill Pickle Slices, 1/8" Crinkle Cut - Pail | 1 / 5 gal | E |
| 80022 | Dill Pickle Slices, 1/8" Crinkle Cut - Jugs | 4 / 1 gal | E |



Southgate - Single Servings

| | | | |
|-------|------------|-------------|----------|
| 94352 | Lasagna | 24 / 7.5 oz | P |
| 94356 | Sketti O's | 24 / 7.5 oz | P |



SunButter

| | | | |
|-------|-------------------------|--------------|-------------------|
| 19368 | SunButter Cup - Natural | 200 / 1.1 oz | S P |
|-------|-------------------------|--------------|-------------------|



Tortilla Chips

| | | | |
|--------|--------------------|-----------|----------------------|
| 261106 | Bulk Tortilla Chip | 6 / 2 lb | E 1/4B |
| 261194 | 2 oz Yellow Rounds | 60 / 2 oz | E 2/4B |



Woodles

| | | | |
|-------|-------------------------------------|------------|-------------------|
| 11933 | Woodles - Whole Grain Ramen Noodles | 144 / 1 oz | E B |
|-------|-------------------------------------|------------|-------------------|



Zee Zee's

| | | | |
|--------|--|--------------|----------------------------------|
| 617612 | Cruncherz - Ranch | 250 / .75 oz | S P |
| 154161 | Red Pepper Hummus | 120 / 3 oz | S 1/2P 1/8V |
| 25200 | Taco Hummus | 120 / 3 oz | S 1/2P 1/8V |
| 87860 | Sunflower Kernels - Roasted - Lightly Salted | 250 / 1 oz | S P |
| 88090 | Sunflower Kernels - Honey Roasted | 250 / 1.2 oz | S P |

S Meets the USDA Smart Snacks In School Guidelines!

E Item is eligible for menuing as long as all meal requirements are met.

Icons for Food Items

B (Grains/Breads) **F** (Fruits) **D** (Dairy)
P (Proteins) **V** (Vegetables)

Items contribute to the USDA Food Buying Guide for Child Nutrition Programs

Peanut Free



Trans-Fat Free



Gluten Free



Whole Grain



Shelf Stable Lunch Kits

just add milk for a reimbursable USDA Lunch!

Locker Mates



Pre-packaged meals that are great for sack lunches or emergency meals.

| | | | |
|--------|---|-------|-------------------------|
| 5-1001 | WOW Butter, Trail Mix, 3ct Whole Grain Grahams, Applesauce, 100% Veggie Juice Blend | 24 ct | S 2P/1/4 B/2F |
| 5-1002 | Cheddar Cheese Stick, Soy Nuts, Whole Grain Cheez-Its, Applesauce, 100% Veggie Juice Blend | 24 ct | S 2P/2B/2F |
| 5-1005 | 2oz Cheddar Cheese Spread, Sunflower Kernels, Dried Fruit Mix, 3 - 2ct WG Crackers 100% Juice | 24 ct | S 2P/B/2F |
| 5603 | Beef Stick, Sunflower Kernels, Applesauce, Animal Crackers, 100% Juice | 24 ct | 1 1/2 P/1/4 B/2F |
| 5604 | Turkey Stick, Soy Nuts, Fruit Bites, Cheez-Its Crackers, 100% Juice | 24 ct | 1 1/2 P/B/2F |

****Check for State Approval prior to using meat sticks as an alternate protein for reimbursement.****

Single Portion Products

Campbell's



| | | | |
|--------------|--|---------------------|------------|
| 04788 | Whole Grain Colors Cheddar Goldfish | 300 / .75 oz | S B |
| 05684 | Whole Grain Sour Cream & Onion Goldfish | 300 / .75 oz | S B |
| 14396 | Whole Grain Pretzel Goldfish | 300 / .75 oz | S B |
| 23088 | Whole Grain Xtra Cheddar Goldfish | 300 / .75 oz | S B |
| 27516 | Whole Grain Mickey Mouse Cheddar Goldfish | 300 / .75 oz | S B |

Cookie Tree Cookies



| | | | |
|-------|-----------------------------------|--------------|----------------|
| 3233 | Whole Grain Double Fudge Cookie | 120 / 1.3 oz | S 1/2 B |
| 3237 | Whole Grain Candy Chip Cookie | 120 / 1.3 oz | S 1/2 B |
| 3239 | Whole Grain Sugar Cookie | 120 / 1.3 oz | S B |
| 3251 | Whole Grain Chocolate Chip Cookie | 120 / 1.3 oz | S 1/2 B |
| 10004 | Whole Grain Brownie | 96 / 1.75 oz | S B |

Darlington



| | | | |
|-------|--|---------------|-------------|
| 70300 | Appleways - Chocolate Chip | 216 / 1.2 oz | S B |
| 70400 | Appleways - Strawberry | 216 / 1.2 oz | S B |
| 70600 | Appleways - Blueberry | 216 / 1.2 oz | S B |
| 71500 | Appleways - Blueberry Lemon Crispy Bites | 108 / 1 oz | S B |
| 74200 | Appleways - Chocolate Chip Waffle Snaps | 180 / 1.9 oz | E 2B |
| 75300 | Appleways - 2 GB Oatmeal Chocolate Chip | 160 / 2.4 oz | E 2B |
| 75400 | Appleways - 2 GB Strawberry Bar | 160 / 2.4 oz | E 2B |
| 76301 | Appleways - Whole Grain Veggie Crispy Crackers | 108 / 1 oz | S B |
| 76302 | Appleways - 2 GB Whole Grain Veggie Crisp Crackers | 180 / 1.85 oz | E 2B |

Dick & Jane Educational Smart Snacks



| | | | |
|------|--|------------|------------|
| 1001 | Food & Nutrition | 120 / 1 oz | S B |
| 1002 | Fun & Fitness | 120 / 1 oz | S B |
| 1003 | Farmers' Market | 120 / 1 oz | S B |
| 8801 | States & Capitols - Special Order Only! | 120 / 1 oz | S B |
| 8802 | Presidents - Special Order Only! | 120 / 1 oz | S B |
| 8803 | English & Spanish - Special Order Only! | 120 / 1 oz | S B |

Single Portion Products

Frito Lay - SS Snacks



| | | | | |
|--------------|---|---------------------|------------|--|
| 11151 | SunChips Original | 104 / 1 oz | E 1½B | |
| 11152 | SunChips Harvest Cheddar | 104 / 1 oz | E 1½B | |
| 36445 | SunChips Garden Salsa | 104 / 1 oz | E 1½B | |
| 78785 | SunChips - Honey BBQ | 104 / 1 oz | E 1½B | |
| 15940 | Heartzels - Rold Gold Pretzels | 104 / .7 oz | S B | |
| 32430 | Rold Gold Pretzels | 88 / 1 oz | E | |
| 30900 | Smartfood White Cheddar Popcorn | 72 / .5 oz | S ½B | |
| 18792 | Reduced Fat Tostitos | 104 / .875 oz | S 1½B | |
| 42537 | Baked Tostitos Scoops | 72 / .875 oz | S 1½B | |
| 21910 | Reduced Fat Cheetos Puffs | 72 / .7 oz | S B | |
| 52889 | Baked Whole Grain Cheetos Flamini' Hot Limon | 104 / .875 oz | S 1½B | |
| 62933 | Baked Whole Grain Cheetos | 104 / .875 oz | S 1½B | |
| 62984 | Baked Whole Grain Cheetos Flamini' Hot | 104 / .875 oz | S 1½B | |
| 32078 | Baked Lays BBQ | 60 / .875 oz | S | |
| 33625 | Baked Lays Regular | 60 / .875 oz | S | |
| 56882 | Baked Ruffles Cheddar & Sour Cream | 60 / .8 oz | S | |
| 31748 | Reduced Fat Doritos Nacho Cheese | 72 / 1 oz | S 1½B | |
| 36096 | Reduced Fat Doritos Cool Ranch | 72 / 1 oz | S 1½B | |
| 49093 | Reduced Fat Doritos Spicy Sweet Chili | 72 / 1 oz | S 1½B | |
| 62829 | Reduced Fat Doritos Flamas | 72 / 1 oz | S 1½B | |
| 67609 | Reduced Fat Doritos Wild White Nacho | 72 / 1 oz | S 1½B | |
| 78095 | Reduced Fat Doritos Golden Sriracha | 72 / 1 oz | S 1½B | |
| 36098 | Chili Cheese Fantastix | 104 / 1 oz | S 1½B | |
| 43578 | Flamini' Hot Fantastix | 104 / 1 oz | S 1½B | |
| 74993 | Ranch Fantastix | 104 / .9 oz | S B | |
| 32405 | Fritos Original | 104 / 1 oz | E | |
| 66689 | Funyuns | 104 / .75 oz | S B | |
| 80488 | Munchies Snack Mix | 104 / .87 oz | S B | |
| 66154 | Grandma's Whole Grain Mini Chocolate Chip Cookies | 80 / 1.22 oz | S B | |

Frito Lay - LSS Snacks



| | | | | |
|-------|---|---------------|------|--|
| 09598 | Reduced Fat Kettle Chips - Applewood Smoked BBQ | 64 / 1.375 oz | S | |
| 25111 | Reduced Fat Kettle Chips - Jalapeno Cheddar | 64 / 1.375 oz | S | |
| 25113 | Reduced Fat Kettle Chips - Salt & Vinegar | 64 / 1.375 oz | S | |
| 25115 | Reduced Fat Kettle Chips - Original | 64 / 1.375 oz | S | |
| 30103 | Reduced Fat Tostitos - 2 GB | 64 / 1.45 oz | S 2B | |
| 44395 | Baked Lays BBQ | 64 / 1.125 oz | S | |
| 44396 | Baked Lays Regular | 64 / 1.125 oz | S | |
| 44400 | Baked Ruffles Cheddar Sour Cream | 64 / 1.125 oz | E | |

Frito Lay - Walking Taco



| | | | | |
|--------------|---------------------------------------|--------------------|-------------|--|
| 20510 | Tostitos Walking Taco | 44 / 1.4 oz | S 2B | |
| 20518 | Doritos Walking Taco | 44 / 1.4 oz | E 2B | |
| 69394 | Fritos Walking Taco | 60 / 1.5 oz | E 2B | |
| 80697 | Spicy Sweet Chili Walking Taco | 44 / 1.4 oz | E 2B | |

J & J Snack Foods



| | | | | |
|-------|-----------------------|------------|-----|--|
| 49193 | Crunch & Crave Churro | 160 / 1 oz | S B | |
|-------|-----------------------|------------|-----|--|

Single Portion Products

General Mills



| | | | | |
|-------|--|--------------|-----|--|
| 11510 | Scooby Doo Fruit Shapes | 96 / .9 oz | S | |
| 11561 | Reduced Sugar Crazy Colors Fruit Roll Ups | 96 / .5 oz | S | |
| 11566 | Reduced Sugar Blastin' Berry Hot Colors Fruit Roll Ups | 96 / .5 oz | S | |
| 29162 | Reduced Sugar Strawberry Blast Fruit Roll Ups | 96 / .5 oz | S | |
| 31913 | Golden Grahams Cereal Bar | 96 / 1.42 oz | SB | |
| 31915 | Trix Cereal Bar | 96 / 1.42 oz | SB | |
| 45576 | Cinnamon Toast Crunch Cereal Bar | 96 / 1.42 oz | SB | |
| 45577 | Cocoa Puffs Cereal Bar | 96 / 1.42 oz | SB | |
| 16854 | 2 GB Cinnamon Toast Crunch Cereal Bar | 48 / 2.5 oz | E2B | |
| 20688 | 2 GB Cocoa Puffs Cereal Bar | 48 / 2.5 oz | E2B | |
| 12400 | Cheex Mix - Traditional | 60 / 1.75 oz | | |
| 31932 | Simply Cheex - Cheddar | 60 / .92 oz | SB | |
| 31933 | Simply Cheex - Chocolate Caramel | 60 / 1.03 oz | SB | |
| 31937 | Simply Cheex - Strawberry Crème | 60 / 1.03 oz | SB | |
| 48341 | Cheex Mix Muddy Buddies | 60 / 1.75 oz | | |

Kelloggs



| | | | | |
|-------|---|---------------|--------|--|
| 11052 | Whole Grain Rice Krispies Treats | 80 / 1.41 oz | SB | |
| 14540 | Mini Whole Grain Rice Krispies Treat | 600 / .42 oz | S1/4B | |
| 14567 | Whole Grain Chocolate Chip Rice Krispies Treats | 80 / 1.59 oz | SB | |
| 26452 | Whole Grain Rice Krispies Treats - Confetti | 80 / 1 oz | SB | |
| 12695 | Chat Snax Vanilla Grahams | 210 / 1 oz | SB | |
| 12956 | Scooby Doo Chocolate Graham Sticks | 210 / 1 oz | SB | |
| 50689 | Scooby Doo Cinnamon Graham Sticks | 210 / 1 oz | SB | |
| 55644 | Bug Bites Cinnamon Graham Crackers | 210 / 1 oz | SB | |
| 40213 | Tiger Bites - Original | 150 / 1 oz | SB | |
| 12431 | Cheez-It Spicy Buffalo Whole Grain Crackers | 175 / .75 oz | SB | |
| 79263 | Cheez-It Singles Whole Grain Crackers | 175 / .75 oz | SB | |
| 24520 | Eggo Cinnamon French Toast Grahams | 100 / 1.76 oz | E2B | |
| 12070 | Pop Tart - Whole Grain Frosted Fudge | 120 / 1.76 oz | S1/4B | |
| 17196 | Pop Tart - Whole Grain Blueberry | 120 / 1.76 oz | SB | |
| 55122 | Pop Tart - Whole Grain Frosted Cinnamon | 120 / 1.75 oz | S1/4B | |
| 55130 | Pop Tart - Whole Grain Strawberry | 120 / 1.76 oz | SB | |
| 12073 | 2 Ct. Pop Tart - Whole Grain Frosted Fudge | 72 / 3.53 oz | E21/4B | |
| 17199 | 2 Ct. Pop Tart - Whole Grain Blueberry | 72 / 3.53 oz | E21/4B | |
| 55125 | 2 Ct. Pop Tart - Whole Grain Frosted Cinnamon | 72 / 3.53 oz | E21/4B | |
| 55133 | 2 Ct. Pop Tart - Whole Grain Strawberry | 72 / 3.53 oz | E21/4B | |
| 59772 | NutriGrain Cereal Bar - Strawberry | 96 / 1.55 oz | SB | |
| 59779 | NutriGrain Cereal Bar - Apple Cinnamon | 96 / 1.55 oz | SB | |
| 90819 | NutriGrain Cereal Bar - Blueberry | 96 / 1.55 oz | SB | |

Kraft



| | | | | |
|-------|-----------------------------------|-------------|---|--|
| 82750 | Grab 'N Snack Pudding - Chocolate | 48 / 3.5 oz | S | |
| 82751 | Grab 'N Snack Pudding - Vanilla | 48 / 3.5 oz | S | |

MJM



| | | | | |
|---------------|--|--------------------|-----|--|
| 7399 | Cinnamon Grahams - 3 pack | 150 / 1 oz | SB | |
| 7400 | Honey Grahams - High Fiber - 3 pack | 150 / 1 oz | SB | |
| 7410 | Sunrise Bites - 1GB | 150 / 1 oz | SB | |
| 7401 | All Sport Bites | 150 / 1 oz | SB | |
| 524150 | Dino Bites - Vanilla | 150 / 1 oz | SB | |
| 7414 | Savory Bites Whole Grain Whole Wheat Cracker - 1GB | 155 / .8 oz | SB | |
| 7402 | Chocolate Bear Grahams | 300 / 1 oz | SB | |
| 7404 | Vanilla Bear Grahams | 300 / 1 oz | SB | |
| 7405 | Strawberry Waffle Grahams | 300 / 1 oz | SB | |
| 7415 | Maple Waffle Grahams | 300 / 1 oz | SB | |
| 4155 | Savory Bites - Pizza | 155 / .8 oz | SB | |
| 74131 | Savory Bites Whole Grain Whole Wheat Cracker - 2GB | 100 / 1.6 oz | E2B | |

Single Portion Products



Nutritional Choices

61002 Brownie Bar 120 / 1.5 oz **S** $\frac{3}{4}$ B



Popcorn Indiana

10084 Popcorn Indiana Sweet & Salty Popcorn 48 / 1 oz **S** **B**

92002 Hot Chocolate Popcorn 50 / .7 oz **S** $\frac{1}{2}$ B



Quaker

43381 Caramel Rice Crisps 60 / .91 oz **S**



Rockin' Ola

4209 Cinnamon Granola Clusters 250 / 1 oz **S** **B**

Welch's Fruit Snacks



11441 Juicefuls - Mixed Fruit 144 / 1.15 oz **S**

14492 Fruit Snacks - Berries & Cherries 144 / 1.5 oz **S**

14498 Fruit Snacks - Mixed Fruit 144 / 1.5 oz **S**



Zee Zee's

604301 Cinnamon Crisp Nutrition Bar 135 / 2.2 oz **E** **2B**

604801 Campfire S'Mores Nutrition Bar 135 / 2.2 oz **E** **2B**

610688 Birthday Grahamz 200 / 1 oz **S** **B**

Childcare Mix & Pour Juice

Arctic Fun - 100% Juice - Clear, Non Staining Flavors



| | | | | |
|--------|---------------------------|--|--------|------------------------|
| 17601 | Apple Juice | | 176091 | Clear Raspberry Juice |
| 17603 | White Grape Juice | | 176121 | Clear Watermelon Juice |
| 176041 | Clear Fruit Punch Juice | | 176171 | Clear Strawberry Juice |
| 176071 | Clear Orange Citrus Juice | | 176211 | Clear Mountain Berry |

Affordable...our lowest price

| | | |
|-----------------|-------------------------|---------------|
| | <u>Case / 6 Bottles</u> | <u>Bottle</u> |
| Price - Syrup | 136.50 | 22.75 |
| Oz - Syrup | 384 | 64 |
| Oz - Juice | 2880 | 480 |
| Gallons - Juice | 22.5 | 3.75 |



Concession Products



Tortilla Chips

261106 Bulk Tortilla Chip 6 / 2 lb **E** $\frac{1}{4}$ B

261194 2 oz Yellow Rounds 60 / 2 oz **E** $\frac{2}{3}$ B



Nacho Cheese

20024 Zesty Cheddar Cheese Sauce - Bag 4 / 140 oz **E**

2002FC Mild Cheese Sauce - Cups 48 / 3.5 oz



Paper Nacho Trays

22061 #200 Paper Trays **Call for Pricing** 4 / 250



Kaiser Pickles

80021 Dill Pickle Slices, 1/8" Crinkle Cut - Pail 1 / 5 gal **E**

80022 Dill Pickle Slices, 1/8" Crinkle Cut - Jugs 4 / 1 gal **E**

S Meets the USDA Smart Snacks In School Guidelines!









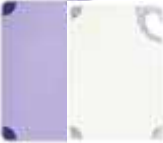

E Item is eligible for menuing as long as all meal requirements are met.

Icons for Food Items

B (Grains/Breads) **F** (Fruits) **D** (Dairy)
P (Proteins) **V** (Vegetables)
 Items contribute to the USDA Food Buying Guide for Child Nutrition Programs

| | | | |
|--|--|--|--|
| | | | |
|--|--|--|--|

Kitchenwares - Call for Pricing

| | | | |
|--|---|--|-------------|
|  | San Jamar - Carton Opener | | |
| | 754011 | Red Carton Opener | 1 Unit |
| | BB100 | Boa Bag Cutter | 1 Unit |
| <hr/> | | | |
|  | San Jamar - Cutting Boards | | |
| | CBG1218WH | Cutting Board - White - 12x18x1/2 | 1 Unit |
| | CBG912WH | Saf T Grip Cutting Board - White - 9x12 | 1 Unit |
| | CBG912PR | Allergen Saf T Cutting Board - Purple - 9x12 | 1 Unit |
| KLRST | Cutting Board Storage Stand | 1 Unit | |
| <hr/> | | | |
|  | San Jamar - Ice Handling | | |
| | 751700 | Saf-T-Scoop & Guardian (12-16oz) | 1 Unit |
| <hr/> | | | |
|  | San Jamar -Kevlar Sleeves | | |
| | 757516 | Sleeve - 500 temp protection | 1 Sleeve |
| <hr/> | | | |
|  | San Jamar - Kleen Pails | | |
| | 751964 | Green Kleen Pail - 6qt | 1Ea |
| 751967 | Red Kleen Pail - 6qt | 1Ea | |
| <hr/> | | | |
|  | San Jamar - Mod Pans | | |
| | 7576712 | 1/2 Modpan with Lid - 9qt | 6 Pans |
| | 7576713 | 1/3 Modpan with Lid - 4qt | 12 Pans |
| 7576714 | 1/4 Modpan with Lid - 4qt | 12 Pans | |
| <hr/> | | | |
|  | San Jamar - Oven Mitts | | |
| | 800FG15BK | 15" Best Guard Oven Mitt - Washable | 2 Mitts |
| | 810CM15 | 15" Best Guard Oven Mitt with Magnet | 1 Mitt |
| | KT0218 | 17" Cool Touch Flame Oven Mitt - 535 temp protection | 1 Mitt |
| | UCMX13BK | 13" Ulti-Grip Oven Mitt - 450 temp protection | 1 Mitt |
| | UCMX15BK | 15" Ulti-Grip Oven Mitt - 450 temp protection | 1 Mitt |
| UCMX17BK | 17" Ulti-Grip Oven Mitt - 450 temp protection | 1 Mitt | |
| <hr/> | | | |
|  | San Jamar - Pan Grabbers | | |
| | 803PG | 9.5" x 11" Grabber with Strap | 12 Grabbers |
| 823TPH | 10" x 11" Grabber | 12 Grabbers | |
| <hr/> | | | |
|  | San Jamar - Pan Holders | | |
| | 802TPH | Terry Cloth 8" x 8" Holder | 12 Holders |
| 802TF | Best Guard 8" x 8" Holder | 12 Holders | |
| <hr/> | | | |
|  | San Jamar - Wrapping Stations | | |
| | SW1218 | Saf-T Wrap Station | 1 Unit |
| | SW1218SC | Saf-T Wrap Station with Cutter | 1 Unit |
| | SW18 | Saf-T Wrap Station - 18" Film Dispenser | 1 Unit |
| | SWX100 | Saf-T Wrap Stacking Station | 1 Unit |
| XSW1218RB | Saf-T Wrap Replacement Blades | 2 Blades | |
| <hr/> | | | |
|  | San Jamar - Ulti-Grip Hot Pads | | |
| | 750077 | 7" x 7" | 1 Pad |
| 751010 | 10" x 10" | 1 Pad | |

*Item numbers in purple are low stock items or special order items.

For more safety and food prep items not listed, please visit www.sanjamar.com

Standing Frame

274-2700 Floor Stand (28"x22")

1 ea

Hanging Frame

274-2704 Black Plastic Frame (28"x22")

1 ea

274-2705 Black Metal Flip Frame (28"x22")

1 ea

Serving Equipment

Sterno Delivery Coolers/Warmers

5000 Milk Crate Kooler

1 ea

5001 Double Milk Crate Kooler

1 ea

5002 Medium Breakfast Kooler (holds 50 bagels)

1 ea

5003 Large Breakfast Kooler (holds 70 bagels)

1 ea

5005 Travel Cart (Milk Koolers & Breakfast Koolers)

1 ea

Techni-Ice, NatureSeal, & Papergoods

Techni Ice

004 Techni Ice Reuseable Ice/Heat Pack

10 Sheets

NatureSeal

34125 1.25lb NatureSeal

1 ea

34380 3.3lb NatureSeal

1 ea

Can Liners **Call For Pricing**

61332 60 gallon, 38x60, 22 Micron

150

61384 33 Gallon, 33x40, 12 Micron

250

Cups **Call For Pricing**

60022 7 oz Plastic

2500

62802 6 oz Foam

1000

Diaper Changing Paper **Call For Pricing**

62773 12 1/8 x 16 3/8 Sheets

1000

Facial Tissue **Call For Pricing**

64230 Standard 100 / 2 Ply

1000

Paper Towels **Call For Pricing**

64233 Household Roll - 85 / 2 Ply

30 / 85

Plastic Ware **Call For Pricing**

13000 Spoon, Medium, White

1000

Trays / Plates **Call For Pricing**

63689 9" Paper

1200

63977 9" Foam, 3 Compartment

500

Toilet Tissue **Call For Pricing**

61974 Toilet Tissue, Individually Wrapped, 500 / 2 Ply

80 Rolls

Sunkist Sectionizer & NatureSeal

Cut your fruits and veggies with
a **Sunkist** Fruit Sectionizer

Equipment

| Item # | Mfg Item# | Item Description |
|---------|-----------|--|
| 732-100 | S-100 | Sunkist Blank Sectionizer (No blade /plunger) |
| 732-102 | S-102 | Sunkist Orange Complete Sectionizer (6 wedge) |
| 732-106 | S-106 | Sunkist Apple Complete Sectionizer (6+core) |
| 732-103 | S-103 | Sunkist 6 Slice Complete Sectionizer (6 slice) |
| 732-200 | S-200 | Sunkist Junior Sectionizer (No Blade) |
| 732-31 | S-31 | Sunkist Production Stand (raises stand for pans) |

Optional Blades and Plungers

| | | |
|--------|-------|---|
| 732-32 | S-32B | 6 Section Blade-Cup & Cover w/Corer (Apple) |
| 732-33 | S-33 | 6 Section Plunger w/Corer (Apple) |

Optional Blades and Plungers

| Item # | Mfg Item# | Item Description |
|--------|-----------|---|
| 732-3 | S-3B | 6 Section Blade-Cup & Cover (Multiple) |
| 732-4 | S-4B | 6 Slice Blade-Cup & Cover (Hard Fruit & Veggie) |
| 732-5 | S-5 | 4 Wedge Blade-Cup & Cover (Multiple) |
| 732-9 | S-9 | 6 Section Plunger (Multiple) |
| 732-10 | S-10 | 6 Slice Plunger (Hard Fruit & Veggie) |
| 732-20 | S-20 | 10 Wedge Blade-Cup & Cover (Multiple)** |
| 732-21 | S-21 | 10 Section Plunger** |
| 732-29 | S-29B | 8 Section Blade-Cup & Cover (Multiple)** |
| 732-30 | S-30B | 2 Halves (Scored in 3 wedges each) |
| 732-35 | S-35B | 2 Halves (Cuts in half) |

****Italicized items are non-stocked items, but can be special ordered.**

Sunkist Sectionizer Exploded View & Parts

Part numbers listed below are Sunkist Item numbers. Please see bottom of page 5 for CFS corresponding item numbers.

Sunkist Sectionizer

Parts Information

Effective date November 1, 2011

- Part Number Parts Description**
- S-1 Foot Pad (set of 6)
 - S-2 Base Assembly
 - S-3B Blade Cup w/cover (6 wedge) (fits S-9)
 - S-4B Blade Cup w/cover (6 slice) (fits S-10)
 - S-5B Blade Cup w/cover (4 wedge) (fits S-9)
 - S-6 Wedger Cup cover (sold w/S-3, S-5, S-29, S-30, S-32, S-35)
 - S-7 Slicer Cup cover (sold w/S-4)
 - S-8 Outer Shell
 - S-8D Pin & Thread Assembly
 - S-9 Plunger Wedger (fits parts S-3, S-5, S-29, S-30, S-35)
 - S-10 Plunger Slicer (fits S-4)
 - S-11 Crossbar Assembly
 - S-11C Brass Knob
 - S-11D Brass Stud
 - S-12 Back Screw #8 x 1/2" (set of 8)
 - S-13 Back Cover
 - S-14 Spring Pin (set of 2)
 - S-15 7 Slice Blade Cup w/cover (fits S-16)
 - S-16 Plunger Tomato Slicer (fits part S-15)
 - S-17 Tomato Set (S-15 & S-16)
 - S-19 Wedger Cup Cover (10 wedge) (sold w/S-20)
 - S-20B Blade Cup w/cover (10 wedge) (fits S-21)
 - S-21 Plunger (fits S-20)
 - S-22 10 Wedge Set (S-20 & S-21)
 - S-23 Gears & Shaft Set
 - S-24 Base Side Screw 6-32 x 1 1/2" (set of 10)
 - S-25 Plastic Shaft Cover
 - S-26 Handle
 - S-27 Knob
 - S-28 Bottom Screw #8 x 1/2" (set of 4)
 - S-29B Blade Cup w/cover (8 wedge) (fits S-9)
 - S-30B Blade Cup w/cover (3-in-1) (fits S-9)
 - S-31 Plastic Production Stand (see below)
 - S-32B Apple Corer Cup (fits S-33)
 - S-33 Apple Plunger (fits S-32)
 - S-34 Apple Corer Set (S-32 & S-33)
 - S-35B Blade Cup w/cover (single) (fits S-9)

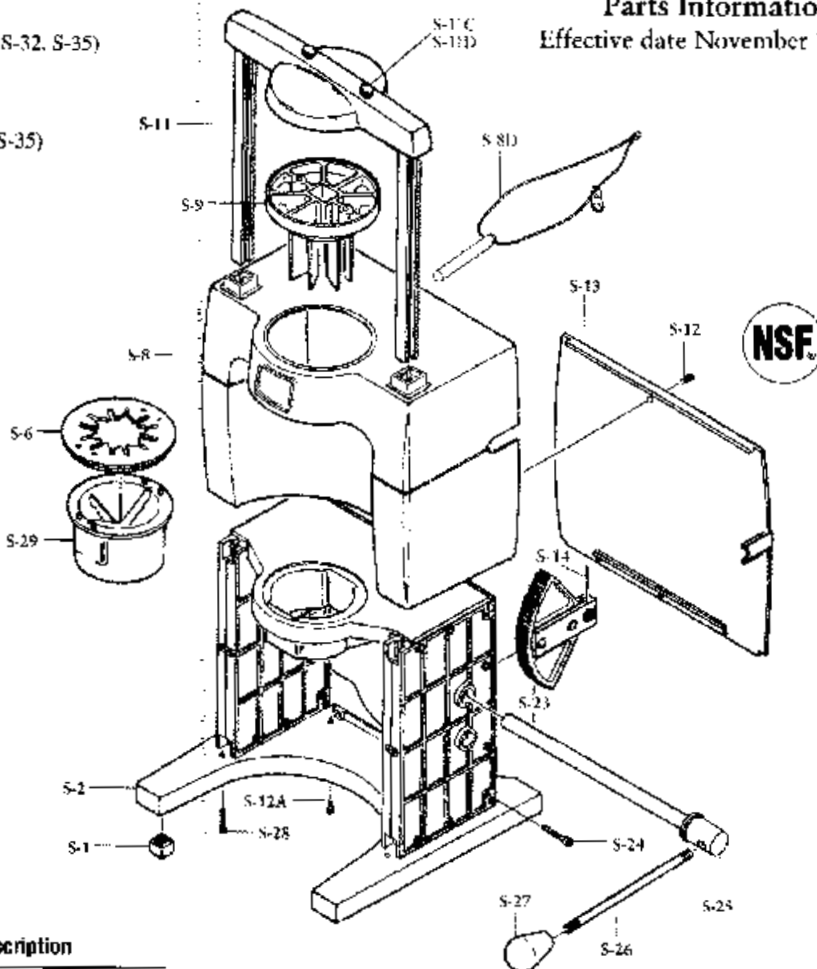

| Complete Sectionizer Model # | Blade Cup Style | Description |
|------------------------------|-----------------|--|
| S-101 | | 4 evenly spaced and cut wedges. |
| S-102 | | 6 evenly spaced and cut wedges. |
| S-103 | | 6 slices 5/16" thick. Must use plunger S-10. |
| S-104 | | 8 evenly spaced and cut wedges. |
| S-105 | | 2 halves scored in 3 wedges each (for school foodservice). |
| S-106 | | 6 evenly spaced and cut wedges with center core removed. Must use plunger #33. |
| S-107 | | Cuts fruit & vegetables in half. |
| S-109 | | 7 evenly spaced slices. Must use plunger S-16. |
| S-110 | | 10 evenly spaced and cut wedges. |

Specifications

Safe...Listed by NSF International®.

Overall Dimensions15 1/2" high, 15 1/4" wide, 13 1/4" deep

Net Weight13 pounds

Shipping Weight15 pounds

Cube2.32

Carton Size17 1/2" L x 13 1/4" W x 17 1/8" H



A sturdy plastic stand that allows serving pans (not included) to pass under the sectionizer for greater production flexibility.

Overall Dimensions5 1/4" high, 14 1/2" wide

Shipping Weight2 pounds, 3 oz.

Reduce prep and serving time with Ekon-O-Pac and Sunkist!



Ekon-O-Pac packaging systems

each system contains a black bag stand & heavy duty bag sealer

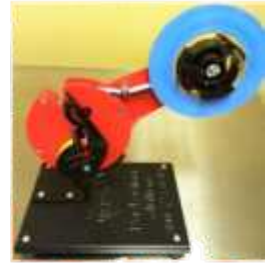

Equipment

| Item # | Item Description |
|--------|----------------------------------|
| 14000Y | Complete System (Stand & Sealer) |
| 14001 | Black Bag Stand |
| 14002Y | Heavy Duty Bag Sealer |

Bag Sealing Tape (Cold Bags Only)

| Item # | Item Description | Qty |
|--------|-------------------|------|
| 14021 | Tape - White | 2500 |
| 14022 | Tape - Light Blue | 2500 |
| 14023 | Tape - Green | 2500 |
| 14024 | Tape - Yellow | 2500 |
| 14025 | Tape - Red | 2500 |
| 14026 | Tape - Orange | 2500 |

Bag Sealing Tape (Hot Bags Only)

| | | |
|-------|--------------|------|
| 14020 | Tape - Clear | 1500 |
|-------|--------------|------|

Recommended & Stocked Bags

| Item # | Bag Size | Qty | Uses |
|--------|-----------|------|----------------------------|
| 14459 | 4.5x9.5 | 5000 | ½ - 1 Cup Fruit/Veggie |
| 14576 | 5x7 | 5000 | ½ - 1 Cup Fruit/Veggie |
| 14686 | 6x8.75 | 5000 | Whole Orange/Apple |
| 14750 | 7.5x10 | 5000 | Lg Melon Wedge/Hoagie Roll |
| 14892 | 8x9x2.5 | 3000 | Sm Meal Sack, Leftovers |
| 14916 | 9x12x2.75 | 3000 | Lg Breakfast / Lunch Sack |
| 14101 | 10x15 | 3000 | XL Breakfast / Lunch Sack |

Ovenable, Vented Hot Bags

| | | | |
|-------|-----|------|--------------------|
| 15788 | 7x9 | 5000 | Large Sandwich Bag |
|-------|-----|------|--------------------|

Mid-Temp, Vented Hot Bags

| | | | |
|-------|-----|------|-----------------|
| 15688 | 6x9 | 5000 | 5" Bun Sandwich |
|-------|-----|------|-----------------|

MicroPerf Hot Bags -Browns/cooks product in the bag

| | | | |
|-------|-----|------|-----------------------------|
| 16696 | 6x9 | 5000 | Chicken, Pizza |
| 16796 | 7x9 | 5000 | Hamburger, Chicken Sandwich |

Ovenable and MidTemp Bags available by special order...with 4 week lead. Ask Sales Person about sizes and pricing.

PARTS LIST BELOW

Ekon-O-Pac Parts

Flat Spring
Item #: 2200-28

Index Wheel
Item #: 2200-30

Tape Wheel
Item #: 2200-40

Coil Spring
Item #: 2200-5

Tape Knife
Item #: 2200-16

Coil Spring
Item #: 2200-5Y

All parts below are in a single part kit. Kit includes tape knife, index wheel, and coil spring.

Old Style Red Ekon-O-Pac Bagging System

Not Pictured:
Trimmer Blade (5 pk)
Item #: 14005
Same Item number for old & new style.
Item # 2200-R - Yellow Rebuild Kit
Item # 2200-WRB - Yellow Tape Wheel Rebuild Kit

Ask your Commercial Foods Sales Rep about in-services for continuing education credits that meet the Federal Guidelines.

Ekon-O-Pac Systems and Bags

* Items highlighted in yellow are stock items. (All other items may be stocked later)

ECON-O-PAC, INC. BAG STAND SYSTEM

| CFS Product #: | Econ-O-Pac, Inc. #: | | Pack | Recommended Use |
|----------------|---------------------|-------------------|------|------------------------------------|
| 14000Y | EPAC 4 System | EPAC 4 System | each | Bag Sealer & Stand (Complete Unit) |
| 14001 | EPAC 4 Bag Stand | EPAC 4 Bag Stand | each | Bag Stand Only. |
| 14002Y | EPAC 4 Bag Sealer | EPAC 4 Bag Sealer | each | Bag Sealer Only. |

Cold Bags

| Product No: | | Bag Size | Pack | Recommended Use |
|-------------|----------|---------------|------|---|
| 14459 | CD4595NV | 4.5 x 9.5 | 5000 | 2-1/2" to 4" Cookie, sliced jicama, cut fresh fruit, cut vegetables, boiled egg & cheese / cracker packet. |
| 14576 | CD57NV | 5.5 x 7 | 5000 | 4" Cookie, cut fresh fruit & vegetables, melon, brownies, hamburger set up, dinner roll, salad dressing packet with crackers. |
| 14686 | CD68NV | 6 x 8.75 | 5000 | Sandwich on 4" bun, melon wedge, cut fruit & vegetables, 2 slice bread flat sandwich, dinner roll. |
| 14750 | CD7510NV | 7.5 x 10 | 5000 | 2 full sandwiches, multiple items in bag, break bag including yogurt, fruit, cold cereal. |
| 14896 | CD89NV | 8 x 9 | 5000 | Large bagel & cream cheese, ex-large cookie, large slice of jerky, Large croissant sandwich or club sandwich. |
| 14892 | SB8925NV | 8 x 9 x 2.5 | 3000 | Triangle sandwich bag. Use our backing board and this bag to bag and seal attractive sandwich. |
| 14916 | BB91GNV | 9 x 12 x 2.75 | 3000 | Breakfast bag. Use of breakfast or meal replacement also for Vending application. |
| 14101 | CD1015NV | 10 x 15 | 3000 | Sack lunch, breakfast in the classroom holds entire replacement meal, tape seal for sanitation and security. |

EPAC OVENABLE VENTED HOT BAGS

| | | | | |
|-------|-------|-------|------|--|
| 15688 | HB68V | 6 x 9 | 5000 | Large hoagie sandwich. |
| 15788 | HB78V | 7 x 9 | 5000 | 5" bun type sandwich, hamburger, cheeseburger, etc. tape seal. |

Foil trays are recommended due to higher temperature capabilities.

EPAC OVENABLE MICRO PERF BAGS

MICRO PERF BROWNING AND CRISPING IN THE BAG. Bag frozen, store in freezer. Prior to serving single layer on sheet pan heat in oven at up to 450 F

| | | | | |
|-------|--------|-------|------|---|
| 16696 | HB68MP | 6 x 9 | 5000 | Chicken nuggets, tator tots, fries, etc. tape seal |
| 16796 | HB78MP | 7 x 9 | 5000 | Larger portion than above, 6" round pizza, pizza slice. |

Ovenable Sealing Tape

| | | | | |
|-------|--------|-------|------|---------------------------------|
| 14020 | 1402 H | Clear | 1500 | Clear only, Temp to 400 degree. |
|-------|--------|-------|------|---------------------------------|

Epac Tape

| Product No: | | Color | Seals/roll | Recommended Use |
|-------------|-------|------------|------------|-------------------------|
| 14021 | 1402W | White | 2500 | 1 roll seals 2500 bags. |
| 14022 | 1402B | Light Blue | 2500 | 1 roll seals 2500 bags. |
| 14023 | 1402G | Green | 2500 | 1 roll seals 2500 bags. |
| 14024 | 1402Y | Yellow | 2500 | 1 roll seals 2500 bags. |
| 14025 | 1402R | Red | 2500 | 1 roll seals 2500 bags. |
| 14026 | 1402O | Orange-Tan | 2500 | 1 roll seals 2500 bags. |

Fruit Sectionizers

Apple and Orange Combined Unit Price

| | | | | |
|---------|--------------------------------------|--------------------|------|---|
| 732-200 | Sunkist Sectionizer Jr. | | each | Sectionizer Jr |
| 732-106 | Sunkist S106 Apple | Sunkist S106 Apple | each | Sectionizer Complete: (Includes: Wedge Plunger S-33 & Blade-Cup & Cover S-32) produces - 6 evenly spaced and cut wedges with center core removed. |
| 732-9 | 6 Section Wedge Plunger (Orange) | S-9 | each | 6-Section Wedge Plunger for use with S-3B (#732-3) |
| 732-3 | 6 Section Blade-Cup & Cover (Orange) | S-3B | each | 6-Section (Orange) Blade-Cup & Cover for use with S-9 (#732-9) |
| 732-10 | 6-Slice Plunger | S-16 | each | 6-Slice Wedge Plunger for use with S-15 (#732-4) |
| 732-4 | 6-Blade Blade-Cup & Cover | S-15 | each | 6-Slice Blade-Cup & Cover for use with S-16 (#732-10) |
| 732-30 | 3-in-1 Blade-Cup | S-30B | each | 2 Halves Scored in 3 Wedges Each, use with 732-9 Plunger |
| 732-35 | Single Blade Cup | S-35B | each | Cuts fruits and vegetables in half, use with 732-9 Plunger |

Item # 272-6215
What makes a Healthy Breakfast Tray

Item # 272-6217
What makes a Healthy Breakfast Dots

Item # 272-6216
What makes a Healthy Breakfast Tray
"Chalk Board" style

Item # 272-6215



Item # 272-6217



Item # 272-6216

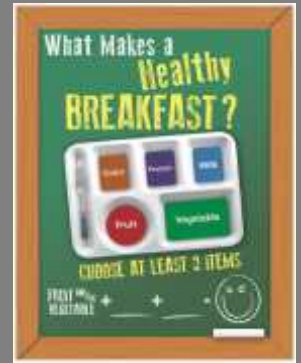

Item # 272-6209-1 (landscape)
What makes a Healthy Lunch Tray

Item # 272-6209 (portrait)
What makes a Healthy Lunch Tray

Item # 272-6213-1
Offer vs Serve

Item # 272-6209-1



Item # 272-6209



Item # 272-6213-1



Item # 272-6208
What makes a Healthy Lunch Dots

Item # 272-6211
What makes a Healthy Lunch Tray
"Chalk Board" style

Item # 272-6208

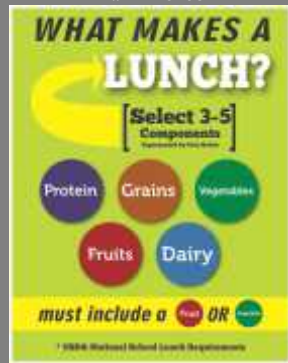

Item # 272-6211



Item # 272-6203
My Plate

Item # 272-6210
Make a Healthy Plate

Item # 272-6203



Item # 272-6210



Item # 272-6214-IS
What makes a Healthy Lunch Tray
Spanish version

Item # 272-6215S
What makes a Healthy Breakfast Tray
Spanish Version

Item # 272-6214-1S



Item # 272-6215S



DRY
ERASE
BOARDS

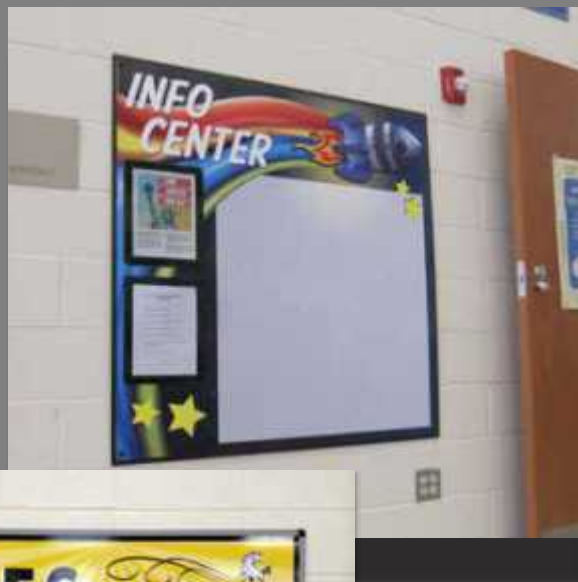
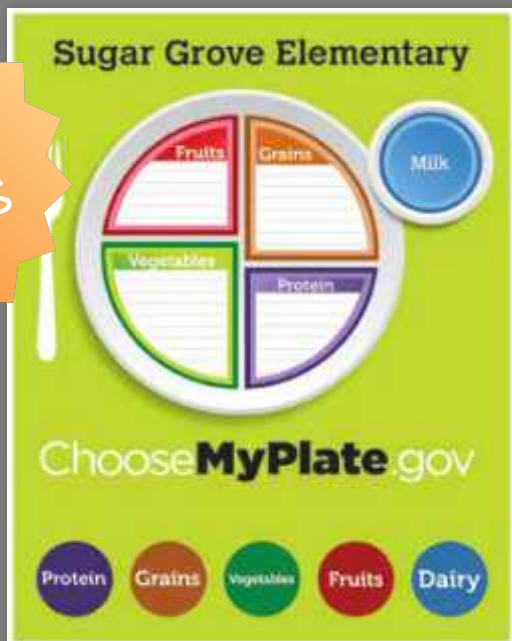

MENU
BOARD
& MENU
STRIPS

NEW!

Dry Erase Menu Strips

- Chicken Alfredo
- Turkey Burger
- Fruit Cocktail
- Green Beans
- Spring Salad
- Apple



- Chicken Alfredo
- Turkey Burger
- Fruit Cocktail
- Green Beans
- Spring Salad
- Apple

Slide In menu strips available via direct print, vinyl print, wet erase. Magnetic menu strips are also available.

CONTACT YOUR

SALES REPRESENTATIVE
TODAY!

(800)283.7437

signs@commercialfoodsystems.com

fax **(317)924.3086**

COMMERCIAL
FOOD SYSTEMS, INC.

Promote School Spirit through Custom Signage!



CONTACT YOUR
COMMERCIAL
FOOD SYSTEMS, INC.
REPRESENTATIVE TODAY