

COMMERCIAL FOOD SYSTEMS, INC.

No Contracts. No Minimums. No Delivery Charges. No Fuel Charges.



SPARKLING ICE.



Campbell's



To insure the most up to date nutritional and allergen information, please contact the manufacturer in question directly. Our peanut free symbol means the manufacturer's ingredient list does not contain peanuts and the manufacturer has issued a peanut free facility statement.

































The nutrition information provided in this brochure reflects the current information provided to Commercial Foods by its suppliers. Prior to consuming the product, individuals with severe food allergies should confirm ingredient information on the actual label of the product.

Allow Commercial Food Systems to be the supplier who sources new products for you. Just ask us!
Tony Gates | Chris Hutton | Beth Schave | Shannon Walls

Tel: 317.926.4237 Toll Free: 800.283.7437 Fax: 317.924.3086
2210 Enterprise Park Place Indianapolis, IN 46218
Order online at: www.commercialfoodsystems.com

ISNA Industry Partner - Indiana Owned & Operated est. 1984

New Items denoted by Bold Red Font on the following pages.

Bum Energy				
	15096 Blue Snow Cone	12 / 12 oz		H 18+
	17529 Root Beer	12 / 12 oz		H 18+
	79015 Pink Lemonade	12 / 12 oz		H 18+
	79038 Dr. Bum	12 / 12 oz		H 18+
	92091 Watermelon	12 / 12 oz		H 18+
Campbell's				
	05684 Whole Grain Sour Cream & Onion Goldfish	300 / .75 o	SB	
Dole				
	00419 Pineapple Cup	36 / 4 oz	SF	
Frito Lay				
	80488 Munchies Snack Mix	104 / .87 o	SB	
	80697 Spicy Sweet Chili Walking Taco	44 / 1.4 oz	E2B	
General Mills - Small Bowl Packs				
	11768 Reduced Sugar Frosted Flakes	96 / 1 oz	SB	
General Mills - Large Bowl Packs				
	23565 Reduced Sugar Frosted Flakes	60 / 2 oz	E2B	
Kellogg's - Small Bowl Packs				
	21149 Cocoa Loops	96 / 1 oz	SB	
Kellogg's - Cereal Pouches				
	21132 Cocoa Loops	60 / 2 oz	E2B	
	71170 Kashi Maple Waffle Bites	100 / 1 oz	SB	
MJM				
	4150 Dino Bites - Vanilla	150 / 1 oz	SB	
	4155 Savory Bites - Pizza	155 / .8 oz	SB	
Old Wisconsin				
	12955 Turkey Stick	144 / .6 oz	S 1/2P	
Ocean Spray				
	01494 Craisins - Fruit Punch	200 / 1.16 c	SF	
Peterson Farms Juice Pouch - 4 oz				
	10113 Apple Juice Pouch	96 / 4 oz		A
	10115 Fruit Punch Pouch	96 / 4 oz		A
	10121 Berry Blend Pouch	96 / 4 oz		A
	10139 Sunrise Blend Pouch	96 / 4 oz		A
	10142 Lemonade Pouch	96 / 4 oz		A
Peterson Farms Juice Pouch - 6 oz				
	10125 Apple Juice Pouch	88 / 6 oz		A
	10127 Berry Blend Pouch	88 / 6 oz		A
	10129 Fruit Punch Pouch	88 / 6 oz		A
	10140 Sunrise Blend Pouch	88 / 6 oz		A
	10143 Lemonade Pouch	88 / 6 oz		A
Sparkling Ice				
	96230 Wild Cherry Lifesavers	12 / 17 oz		H
	96232 Pineapple Lifesavers	12 / 17 oz		H
	96236 Strawberry Lifesavers	12 / 17 oz		H
Sparkling Ice + Caffeine				
	4934 Orange Cream	12 / 16 oz		H
Zee Zee's				
	621354 Sour Strawberry Raisins	120 / 1.45 c	SF	
	621355 Sour Blue Raspberry Raisins	120 / 1.45 c	SF	
Uptime Energy				
	91972 Original Citrus	12 / 12 oz		H
	91992 Blood Orange	12 / 12 oz		H
	92172 Blueberry Pomegranate	12 / 12 oz		H

Icons for Water, Juice, & Other Beverages

A Compliant for Elementary, Middle, & High Schools

M Compliant for Middle & High Schools, **NOT** Elementary Schools

H Compliant for **HIGH SCHOOLS ONLY!**

18+ NOT Recommended for persons 18 years and younger!

Icons for Food Items

S Meets the USDA Smart Snacks In School Guidelines!

E Item is eligible for menuing as long as all meal requirements are met.

B (Grains/Breads) **F** (Fruits) **D** (Dairy) **P** (Proteins) **V** (Vegetables)
Items contribute to the USDA Food Buying Guide for Child Nutrition Programs



Water, Juice, & Other Beverages

A Compliant for Elementary, Middle, & High Schools **M** Compliant for Middle & High Schools, **NOT** Elementary Schools **H** Compliant for HIGH SCHOOLS ONLY! **18+** NOT Recommended for persons 18 years and younger!



Arizona Tea
73049 Arnold Palmer Zero 12 / 11.5 oz **H**



Bum Energy
15096 Blue Snow Cone 12 / 12 oz **H** 18+
17529 Root Beer 12 / 12 oz **H** 18+
79015 Pink Lemonade 12 / 12 oz **H** 18+
79038 Dr. Bum 12 / 12 oz **H** 18+
92091 Watermelon 12 / 12 oz **H** 18+



Ice Mountain Natural Spring Water
 7091 8 oz Bottle 48 / 8 oz **A**
 7093 16.9 oz Bottle 40 / 16.9 oz **A**



IZZE
 01146 Sparkling Strawberry 24 / 8.4 oz **M**
 15023 Sparkling Blackberry 24 / 8.4 oz **M**
 15054 Sparkling Clementine 24 / 8.4 oz **M**
 15078 Sparkling Apple 24 / 8.4 oz **M**



Heartland Coffee **Case Yield: 960 ounces**
 309322 Java House Coffee **Approximately 120 - 8 oz servings** 6 / 32 oz **H**



Frazil **Must buy 20 case minimum per school year to get equipment.**
 22014 Blue Razzmatazz **Case Yield: 1152 ounces** 144 / 8 oz **A**
 22021 Strawberry Ice **Case=Six 32 oz Bottles** 144 / 8 oz **A**
 22083 Triple Berry **Approximately 144 8 - 8oz servings** 144 / 8 oz **A**



Juicy Juice - 100% Juice 4.23oz
 00147 Juicy Juice - Kiwi Strawberry 40 / 4.23 oz **A**
 14523 Juicy Juice - Apple 40 / 4.23 oz **A**
 25216 Juicy Juice - Fruit Punch 40 / 4.23 oz **A**
 52179 Juicy Juice - Orange Tangerine 40 / 4.23 oz **A**
 88579 Juicy Juice - Berry 40 / 4.23 oz **A**
 88977 Juicy Juice - Grape 40 / 4.23 oz **A**



Juicy Juice - 100% Juice 6.75oz
 15794 Juicy Juice - Apple 32 / 6.75 oz **A**
 15896 Juicy Juice - Kiwi Strawberry 32 / 6.75 oz **A**
 52479 Juicy Juice - Grape 32 / 6.75 oz **A**
 79564 Juicy Juice - Fruit Punch 32 / 6.75 oz **A**
 84125 Juicy Juice - Orange Tangerine 32 / 6.75 oz **A**
 87776 Juicy Juice - Berry 32 / 6.75 oz **A**



Juicy Juice - 100% Juice 10oz Bottle
 00011 Juicy Juice - Apple 24 / 10 oz **M**
 00014 Juicy Juice - Fruit Punch 24 / 10 oz **M**
 00080 Juicy Juice - Grape 24 / 10 oz **M**
 00094 Juicy Juice - Orange Tangerine 24 / 10 oz **M**



Juicy Juice - 100% Veggie & Fruit Juice **Meets Orange Vegetables**
 00066 Veggie & Fruit Orange Medley - 4.23 oz 40 / 4.23 oz **A**
 00146 Rainbow Punch 32 / 6.75 oz **A**



Kikkoman Pearl Soy Milk - Organic
 60085 Chocolate 24 / 8.25 oz **A**
 60087 Vanilla 24 / 8.25 oz **A**



Milk - Shelf Stable
 0113 Fat Free Chocolate 27 / 8 oz **A**
 4672 1% White 27 / 8 oz **A**

Water, Juice, & Other Beverages

PepsiCo



159301	Life WTR	12 / 24 oz	A
121347	Pepsi Zero	24 / 16.9 oz	H
192475	Mt. Dew Zero	24 / 16.9 oz	H
198561	Dr. Pepper Zero	24 / 16.9 oz	H
325576	Wild Cherry Pepsi Zero	24 / 16.9 oz	H

Peterson Farms Juice Pouch - 4 oz



10113	Apple Juice Pouch	96 / 4 oz	A
10115	Fruit Punch Pouch	96 / 4 oz	A
10121	Berry Blend Pouch	96 / 4 oz	A
10139	Sunrise Blend Pouch	96 / 4 oz	A
10142	Lemonade Pouch	96 / 4 oz	A

Peterson Farms Juice Pouch - 6 oz



10125	Apple Juice Pouch	88 / 6 oz	A
10127	Berry Blend Pouch	88 / 6 oz	A
10129	Fruit Punch Pouch	88 / 6 oz	A
10140	Sunrise Blend Pouch	88 / 6 oz	A
10143	Lemonade Pouch	88 / 6 oz	A

Peterson Farms - Cool Tropics Slush Pouch - 4 oz



12002	Kiwi Strawberry Slush Pouch	96 / 4 oz	A
12004	Paradise Punch Slush Pouch	96 / 4 oz	A
13001	Blue Raspberry Slush Pouch	96 / 4 oz	A

Popwell Soda



95968	Cherry Citrus	12 / 12 oz	H
95970	Blackberry Lime	12 / 12 oz	H
96059	Orange Cream	12 / 12 oz	H

Quaker - Gatorade Zero



04212	Gatorade Zero - Lemon Lime	24 / 20 oz	H
04214	Gatorade Zero - Glacier Cherry	24 / 20 oz	H
04318	Gatorade Zero - Orange	24 / 20 oz	H
04354	Gatorade Zero - Glacier Freeze	24 / 20 oz	H
04706	Gatorade Zero - Cool Blue	24 / 20 oz	H
04338	Gatorade Zero - Orange	24 / 12 oz	H
04339	Gatorade Zero - Glacier Cherry	24 / 12 oz	H
04342	Gatorade Zero - Glacier Freeze	24 / 12 oz	H
04710	Gatorade Zero - Cool Blue	24 / 12 oz	H
05504	Gatorade Zero - Watermelon Splash	24 / 12 oz	H

Quaker - Propel









01358	Propel - Watermelon	12 / 20 oz	H
70777	Propel - Berry	12 / 20 oz	H
70778	Propel - Kiwi Strawberry	12 / 20 oz	H
70779	Propel - Grape	12 / 20 oz	H

Sparkling Ice





91030	Black Raspberry	12 / 17 oz	H
91031	Orange Mango	12 / 17 oz	H
91032	Kiwi Strawberry	12 / 17 oz	H
91035	Lemonade	12 / 17 oz	H
94033	Coconut Pineapple	12 / 17 oz	H
95029	Strawberry Lemonade	12 / 17 oz	H
95084	Cherry Limeade	12 / 17 oz	H
95087	Strawberry Watermelon	12 / 17 oz	H
95211	Black Cherry	12 / 17 oz	H
95268	Grape Raspberry	12 / 17 oz	H
96230	Wild Cherry Lifesavers	12 / 17 oz	H
96232	Pineapple Lifesavers	12 / 17 oz	H
96236	Strawberry Lifesavers	12 / 17 oz	H

Water, Juice, & Other Beverages

	Nature's Twist			
	00194	Lemonade	24 / 12 oz	H
	00193	Strawberry Lemonade	24 / 12 oz	H
	Sparkling Ice + Caffeine			
	1905	Strawberry Citrus	12 / 16 oz	H
	1982	Black Raspberry	12 / 16 oz	H
	1983	Blue Raspberry	12 / 16 oz	H
	1984	Citrus Twist	12 / 16 oz	H
	2838	Tropical Punch	12 / 16 oz	H
	4934	Orange Cream	12 / 16 oz	H
	Tasty Brands			
	68003	Perk Cold Brew Coffee Milk - Vanilla	24 / 8 oz	H
	The Switch - 100% Juice with Carbonation			
	312	Black Cherry	24 / 8 oz	A
	314	Orange Tangerine	24 / 8 oz	A
	315	Fruit Punch	24 / 8 oz	A
	316	Watermelon Strawberry	24 / 8 oz	A
	337	Kiwi Berry	24 / 8 oz	A
	Uptime Energy			
	91972	Original Citrus	12 / 12 oz	H
	91992	Blood Orange	12 / 12 oz	H
	92172	Blueberry Pomegranate	12 / 12 oz	H
	Yoo-Hoo			
	28097	Chocolate Drink	24 / 11 oz	

Breakfast Kits just add a 2nd fruit/vegetable & milk for a complete reimbursable USDA breakfast!

	Breakfast On The Go ≡ <i>(Developed for Breakfast in the Classroom)</i>			
	40013	Whole Grain Single Cinnamon Pop Tart 1 GB Whole Grain Snack 4.23 oz 100% Grape Juice	24 ct	S2B/F 🍌 🍌 🍌
	40014	Whole Grain Single Strawberry Pop Tart 1 GB Whole Grain Snack 4.23 oz 100% Berry Juice	24 ct	S2B/F 🍌 🍌 🍌
	40017	Kellogg's Kashi Pouch Cereal - Variety 1 GB Whole Grain Snack 4.23 oz 100% Orange-Tangerine Juice	24 ct	S2B/F 🍌 🍌 🍌
	40018	Whole Grain Single Fudge Pop Tart 1 GB Whole Grain Snack 4.23 oz 100% Grape Juice	24 ct	S2B/F 🍌 🍌 🍌
	Breakfast On The Go ≡			
	40001	Cinnamon Toasters™ cereal bowl 1 GB Whole Grain Snack 4.23 oz 100% Apple Juice	24 ct	S2B/F 🍌 🍌 🍌
	40004	General Mills Reese Puffs cereal bowl 1 GB Whole Grain Snack 4.23 oz 100% Orange-Tangerine Juice	24 ct	S2B/F 🍌 🍌 🍌
	40005	General Mills Cocoa Puffs cereal bowl 1 GB Whole Grain Snack 4.23 oz 100% Orange-Tangerine Juice	24 ct	S2B/F 🍌 🍌 🍌
	40008	Marshmallow Matey's® cereal bowl 1 GB Whole Grain Snack 4.23 oz 100% Fruit Punch Juice	24 ct	S2B/F 🍌 🍌 🍌
	40009	General Mills Trix cereal bowl 1 GB Whole Grain Snack 4.23 oz 100% Berry Juice	24 ct	S2B/F 🍌 🍌 🍌

Breakfast Cereals - Bowl Packs

Malt-O-Meal / Post - Small Bowls



542	Crispy Rice / Kellogg's Rice Krispies® - LOW SUGAR	96 / .63 oz	1/2B	
1015	Frosted Flakes / Kellogg's® Frosted Flakes	96 / 1 oz	B	
1315	Tootie Fruities® / Kellogg's Froot Loops®	96 / .75 oz	3/4B	
1515	Coco-Roos® / GM Cocoa Puffs®	96 / .87 oz	3/4B	
2415	Berry Colossal Crunch® / Cap'n Crunch Berries	96 / 1 oz	B	
3915	Cinnamon Toasters™ / GM Cinnamon Toast Crunch®	96 / 1 oz	SB	
4515	Honey Graham Toasters™ / GM Golden Grahams®	96 / 1 oz	B	
27164	Scooters / GM Cherrios® - LOW SUGAR	96 / 1 oz	SB	
27596	Marshmallow Matey's® - LOW SUGAR	96 / 1 oz	SB	
27597	Honey Scooters® - LOW SUGAR	96 / 1 oz	SB	
29594	Fruity Pebbles	96 / 1 oz	B	

General Mills - Small Bowl Packs



11768	Reduced Sugar Frosted Flakes	96 / 1 oz	SB	
11943	Golden Grahams - LOW SUGAR	96 / 1 oz	EB	
18446	Blueberry Chex - LOW SUGAR	96 / 1 oz	SB	
18447	Honey Cheerios- LOW SUGAR	96 / 1 oz	SB	
22488	Reduced Sugar Lucky Charms - LOW SUGAR	96 / 1 oz	EB	
29444	Reduced Sugar Cinnamon Toast Crunch - LOW SUGAR	96 / 1 oz	SB	
31919	Reese Puffs	96 / 1 oz	SB	
31888	Reduced Sugar Cocoa Puffs - LOW SUGAR	96 / 1.06 oz	SB	
31921	Rice Chex - LOW SUGAR	96 / 1 oz	EB	
31922	Reduced Sugar Trix - LOW SUGAR	96 / 1 oz	SB	
32262	Cheerios - LOW SUGAR	96 / 1 oz	SB	
38387	Cinnamon Chex - LOW SUGAR	96 / 1 oz	SB	



Kelloggs - Small Bowl Packs

21149	Cocoa Loops	96 / 1 oz	SB	
--------------	--------------------	------------------	-----------	--

Malt-O-Meal / Post - Large Bowls (Faster Breakfast Service with 2 Breads in 1 Bowl!)



8676	Honey Scooters® - LOW SUGAR	48 / 2 oz	2B	
00955	Frosted Flakes / Kellogg's® Frosted Flakes	48 / 2 oz	2B	
03759	Honey Graham Toasters™ / GM Golden Grahams®	48 / 2 oz	2B	
05940	Marshmallow Matey's® / GM Lucky Charms®	48 / 2 oz	2B	
13820	Cinnamon Toasters™ - LOW SUGAR	48 / 2 oz	2B	

General Mills - Large Bowl Packs



14883	Cinnamon Chex - LOW SUGAR	60 / 2 oz	E2B	
14885	Reduced Sugar Cocoa Puffs - LOW SUGAR	60 / 2 oz	E2B	
14886	Reduced Sugar Cinnamon Toast Crunch - LOW SUGAR	60 / 2 oz	E2B	
17262	Blueberry Chex - LOW SUGAR	60 / 2 oz	E2B	
18448	Honey Cheerios - LOW SUGAR	60 / 2 oz	E2B	
19567	Reduced Sugar Trix - LOW SUGAR	60 / 2 oz	E2B	
22489	Lucky Charms - LOW SUGAR	60 / 2 oz	E2B	
23565	Reduced Sugar Frosted Flakes	60 / 2 oz	E2B	

***LOW SUGAR - cereal contains 6g of sugar or less**

Breakfast Cereals - Pouches & Bulk



Kellogg's - Cereal Pouches

- 21132 Cocoa Loops**
- 71161 Kashi Strawberry Banana Smoothie Loops
- 71170 Kashi Maple Waffle Bites**

60 / 2 oz
100 / 1 oz
100 / 1 oz



Bulk Cereal - Kellogg's

- 04983 Granola Crunch Clusters

4 / 50 oz



Fruits



Apple Sauce Cups - Cherry Central

- 9116 Apple Sauce - Plain
- 9118 Apple Sauce - Strawberry
- 9119 Apple Sauce - Cinnamon
- 9700 Apple Sauce - Blue Raspberry

96 / 4.5 oz
96 / 4.5 oz
96 / 4.5 oz
96 / 4.5 oz



Apple Sauce Cups - Peterson Farms - Non-Commodity

- 10064 Apple Sauce - Plain**
- 10065 Apple Sauce - Cinnamon**
- 10097 Apple Sauce - Grape**
- 10135 Apple Sauce - Razzleberry**

96 / 4.5 oz
96 / 4.5 oz
96 / 4.5 oz
96 / 4.5 oz



Cherry Central

- 02136 Dried Cherries
- 49602 Sour Berries

100 / 1.36 oz
100 / 1.27 oz



Dole

- 03352 Wiggles - Orange
- 03353 Wiggles - Strawberry
- 03354 Wiggles - Cherry
- 00419 Pineapple Cup**

36 / 4.3 oz
36 / 4.3 oz
36 / 4.3 oz
36 / 4 oz



Fruit Cups (Seasonally Available) - NO SUGAR ADDED

- 7602 Peach Fruit Cups
- 7603 Mandarin Orange Fruit Cups
- 7604 Mixed Fruit Cups
- 7605 Diced Pear Fruit Cups

96 / 4.5 oz
96 / 4.5 oz
96 / 4.5 oz
96 / 4.5 oz



Ocean Spray

- 01491 Lower Sugar Craisins - Cherry
- 01492 Lower Sugar Craisins - Strawberry
- 01493 Lower Sugar Craisins - Watermelon
- 01494 Lower Sugar Craisins - Fruit Punch**

200 / 1.16 oz
200 / 1.16 oz
200 / 1.16 oz
200 / 1.16 oz



Raisels

- 10569 Tropical Fruit Raisels - NO SUGAR ADDED
- 10570 Grape Raisels - NO SUGAR ADDED

200 / 1.35 oz
200 / 1.35 oz



Tree Top

- 105260 Apple Crisps - Strawberry
- 105261 Apple Crisps - Plain

125 / .34 oz
125 / .34 oz



Zee Zee's

- 620935 Mixzees Dried Fruit
- 621169 Raisins
- 621354 Sour Strawberry Raisins**
- 621355 Sour Blue Raspberry Raisins**

120 / 1.33 oz
120 / 1.33 oz
120 / 1.45 oz
120 / 1.45 oz



S Meets the USDA Smart Snacks In School Guidelines!

E Item is eligible for menuing as long as all meal requirements are met.

Icons for Food Items

B (Grains/Breads) **F** (Fruits) **D** (Dairy)
P (Proteins) **V** (Vegetables)

Items contribute to the USDA Food Buying Guide for Child Nutrition Programs



Components & Condiments



Backpack Yogurt

782953	Shelf Stable Yogurt - Summer Berry	48 / 4 oz	S P
72953	Shelf Stable Yogurt - Strawberry	48 / 4 oz	S P



Butter Buds

49835	Butter Buds	24 / 4 oz	E
56217	Buttermist Spray	6 / 17 oz	E
56367	Garlic Buttermist Spray	6 / 17 oz	E



DYMA Brands

73014	Low Sodium Light Ranch Pouch	200 / 12 gr	E
77002	BBQ Cup	100 / 1 oz	E
77004	Buffalo Ranch Dipping Sauce	100 / 1 oz	E
77005	Dynamite Sauce	100 / 1 oz	E
77007	Honey Mustard Cup	100 / 1 oz	E
77013	Low Sodium Ranch Cup	100 / 1 oz	E
77014	Ranch Cup	100 / 1 oz	E
85837	Chick n Dippin Sauce	100 / 1 oz	E
86420	Peanut Butter & Grape Jelly Pack	200 / 2.12 oz	E P



Jack Links

7717	Jacks Links Jerky - Teriyaki	48 / .85 oz	S P
7721	Jacks Links Jerky - Original	48 / .85 oz	S P



Old Wisconsin

12948	Beef Stick	144 / .5 oz	S 1/2 P
12955	Turkey Stick	144 / .6 oz	S 1/2 P



Perfect Servings

15075	Fast & Easy Microwavable Mac & Cheese	100 / 2.15 oz	E
-------	---------------------------------------	---------------	----------



Kaiser Pickles

80021	Dill Pickle Slices, 1/8" Crinkle Cut - Pail	1 / 5 gal	E
80022	Dill Pickle Slices, 1/8" Crinkle Cut - Jugs	4 / 1 gal	E



Southgate - Single Servings

94352	Lasagna	24 / 7.5 oz	P
94356	Sketti O's	24 / 7.5 oz	P



SunButter

19368	SunButter Cup - Natural	200 / 1.1 oz	S P
-------	-------------------------	--------------	-------------------



Tortilla Chips

261106	Bulk Tortilla Chip	6 / 2 lb	E 1/4 B
261194	2 oz Yellow Rounds	60 / 2 oz	E 2/4 B



Woodles

11933	Woodles - Whole Grain Ramen Noodles	144 / 1 oz	E B
-------	-------------------------------------	------------	-------------------



Zee Zee's

617612	Cruncherz - Ranch	250 / .75 oz	S P
154161	Red Pepper Hummus	120 / 3 oz	S 1/2 P 1/8 V
25200	Taco Hummus	120 / 3 oz	S 1/2 P 1/8 V
87860	Sunflower Kemels - Roasted - Lightly Salted	250 / 1 oz	S P
88090	Sunflower Kemels - Honey Roasted	250 / 1.2 oz	S P

S Meets the USDA Smart Snacks In School Guidelines!

E Item is eligible for menuing as long as all meal requirements are met.

Icons for Food Items

B (Grains/Breads) **F** (Fruits) **D** (Dairy)
P (Proteins) **V** (Vegetables)

Items contribute to the USDA Food Buying Guide for Child Nutrition Programs

Peanut Free



Trans-Fat Free



Gluten Free



Whole Grain



Shelf Stable Lunch Kits

just add milk for a reimbursable USDA Lunch!



Pre-packaged meals that are great for sack lunches or emergency meals.

Locker Mates

5-1001	WOW Butter, Trail Mix, 3ct Whole Grain Grahams, Applesauce, 100% Veggie Juice Blend	24 ct	S 2P/1/4 B/2F
5-1002	Cheddar Cheese Stick, Soy Nuts, Whole Grain Cheez-Its, Applesauce, 100% Veggie Juice Blend	24 ct	S 2P/2B/2F
5-1005	2oz Cheddar Cheese Spread, Sunflower Kernels, Dried Fruit Mix, 3 - 2ct WG Crackers 100% Juice	24 ct	S 2P/B/2F
5603	Beef Stick, Sunflower Kernels, Applesauce, Animal Crackers, 100% Juice	24 ct	1 1/2 P/1/4 B/2F
5604	Turkey Stick, Soy Nuts, Fruit Bites, Cheez-Its Crackers, 100% Juice	24 ct	1 1/2 P/B/2F

****Check for State Approval prior to using meat sticks as an alternate protein for reimbursement.****

Single Portion Products



Campbell's

04788	Whole Grain Colors Cheddar Goldfish	300 / .75 oz	S B
05684	Whole Grain Sour Cream & Onion Goldfish	300 / .75 oz	S B
14396	Whole Grain Pretzel Goldfish	300 / .75 oz	S B
23088	Whole Grain Xtra Cheddar Goldfish	300 / .75 oz	S B
27516	Whole Grain Mickey Mouse Cheddar Goldfish	300 / .75 oz	S B



Cookie Tree Cookies

3233	Whole Grain Double Fudge Cookie	120 / 1.3 oz	S 1/2 B
3237	Whole Grain Candy Chip Cookie	120 / 1.3 oz	S 1/2 B
3239	Whole Grain Sugar Cookie	120 / 1.3 oz	S B
3251	Whole Grain Chocolate Chip Cookie	120 / 1.3 oz	S 1/2 B
10004	Whole Grain Brownie	96 / 1.75 oz	S B



Darlington

70300	Appleways - Chocolate Chip	216 / 1.2 oz	S B
70400	Appleways - Strawberry	216 / 1.2 oz	S B
70600	Appleways - Blueberry	216 / 1.2 oz	S B
71500	Appleways - Blueberry Lemon Crispy Bites	108 / 1 oz	S B
74200	Appleways - Chocolate Chip Waffle Snaps	180 / 1.9 oz	E 2B
75300	Appleways - 2 GB Oatmeal Chocolate Chip	160 / 2.4 oz	E 2B
75400	Appleways - 2 GB Strawberry Bar	160 / 2.4 oz	E 2B
76301	Appleways - Whole Grain Veggie Crispy Crackers	108 / 1 oz	S B
76302	Appleways - 2 GB Whole Grain Veggie Crisp Crackers	180 / 1.85 oz	E 2B



Dick & Jane Educational Smart Snacks

1001	Food & Nutrition	120 / 1 oz	S B
1002	Fun & Fitness	120 / 1 oz	S B
1003	Farmers' Market	120 / 1 oz	S B
8801	States & Capitols - Special Order Only!	120 / 1 oz	S B
8802	Presidents - Special Order Only!	120 / 1 oz	S B
8803	English & Spanish - Special Order Only!	120 / 1 oz	S B

Single Portion Products

Frito Lay - SS Snacks



11151	SunChips Original	104 / 1 oz	E 1½B	
11152	SunChips Harvest Cheddar	104 / 1 oz	E 1½B	
36445	SunChips Garden Salsa	104 / 1 oz	E 1½B	
78785	SunChips - Honey BBQ	104 / 1 oz	E 1½B	
15940	Heartzels - Rold Gold Pretzels	104 / .7 oz	S B	
32430	Rold Gold Pretzels	88 / 1 oz	E	
30900	Smartfood White Cheddar Popcorn	72 / .5 oz	S ½B	
18792	Reduced Fat Tostitos	104 / .875 oz	S 1½B	
42537	Baked Tostitos Scoops	72 / .875 oz	S 1½B	
21910	Reduced Fat Cheetos Puffs	72 / .7 oz	S B	
52889	Baked Whole Grain Cheetos Flamini' Hot Limon	104 / .875 oz	S 1½B	
62933	Baked Whole Grain Cheetos	104 / .875 oz	S 1½B	
62984	Baked Whole Grain Cheetos Flamini' Hot	104 / .875 oz	S 1½B	
32078	Baked Lays BBQ	60 / .875 oz	S	
33625	Baked Lays Regular	60 / .875 oz	S	
56882	Baked Ruffles Cheddar & Sour Cream	60 / .8 oz	S	
31748	Reduced Fat Doritos Nacho Cheese	72 / 1 oz	S 1½B	
36096	Reduced Fat Doritos Cool Ranch	72 / 1 oz	S 1½B	
49093	Reduced Fat Doritos Spicy Sweet Chili	72 / 1 oz	S 1½B	
62829	Reduced Fat Doritos Flamas	72 / 1 oz	S 1½B	
67609	Reduced Fat Doritos Wild White Nacho	72 / 1 oz	S 1½B	
78095	Reduced Fat Doritos Golden Sriracha	72 / 1 oz	S 1½B	
36098	Chili Cheese Fantastix	104 / 1 oz	S 1½B	
43578	Flamini' Hot Fantastix	104 / 1 oz	S 1½B	
74993	Ranch Fantastix	104 / .9 oz	S B	
32405	Fritos Original	104 / 1 oz	E	
66689	Funyuns	104 / .75 oz	S B	
80488	Munchies Snack Mix	104 / .87 oz	S B	
66154	Grandma's Whole Grain Mini Chocolate Chip Cookies	80 / 1.22 oz	S B	

Frito Lay - LSS Snacks



09598	Reduced Fat Kettle Chips - Applewood Smoked BBQ	64 / 1.375 oz	S	
25111	Reduced Fat Kettle Chips - Jalapeno Cheddar	64 / 1.375 oz	S	
25113	Reduced Fat Kettle Chips - Salt & Vinegar	64 / 1.375 oz	S	
25115	Reduced Fat Kettle Chips - Original	64 / 1.375 oz	S	
30103	Reduced Fat Tostitos - 2 GB	64 / 1.45 oz	S 2B	
44395	Baked Lays BBQ	64 / 1.125 oz	S	
44396	Baked Lays Regular	64 / 1.125 oz	S	
44400	Baked Ruffles Cheddar Sour Cream	64 / 1.125 oz	E	

Frito Lay - Walking Taco



20510	Tostitos Walking Taco	44 / 1.4 oz	S 2B	
20518	Doritos Walking Taco	44 / 1.4 oz	E 2B	
69394	Fritos Walking Taco	60 / 1.5 oz	E 2B	
80697	Spicy Sweet Chili Walking Taco	44 / 1.4 oz	E 2B	

J & J Snack Foods



49193	Crunch & Crave Churro	160 / 1 oz	S B	
-------	-----------------------	------------	-----	--

Single Portion Products

	Popcorn Indiana				
	10084	Popcorn Indiana Sweet & Salty Popcorn	48 / 1 oz	S B	
	92002	Hot Chocolate Popcorn	50 / .7 oz	S 1/2 B	

	Quaker				
43381	Caramel Rice Crisps	60 / .91 oz	S		

	Rockin' Ola				
4209	Cinnamon Granola Clusters	250 / 1 oz	S B		

Welch's Fruit Snacks					
	11441	Juicefuls - Mixed Fruit	144 / 1.15 oz	S	
	14492	Fruit Snacks - Berries & Cherries	144 / 1.5 oz	S	
	14498	Fruit Snacks - Mixed Fruit	144 / 1.5 oz	S	

Zee Zee's					
	604301	Cinnamon Crisp Nutrition Bar	135 / 2.2 oz	E 2B	
	604801	Campfire S'Mores Nutrition Bar	135 / 2.2 oz	E 2B	
	610688	Birthday Grahansz	200 / 1 oz	S B	

Childcare Mix & Pour Juice

Arctic Fun - 100% Juice - Clear, Non Staining Flavors

	17601	Apple Juice		176091	Clear Raspberry Juice	A
	17603	White Grape Juice		176121	Clear Watermelon Juice	
	176041	Clear Fruit Punch Juice		176171	Clear Strawberry Juice	
	176071	Clear Orange Citrus Juice		176211	Clear Mountain Berry	
			<i>Affordable...our lowest price</i>			
			<i>Case / 6 Bottles</i>	<i>Bottle</i>		
		<i>Price - Syrup</i>	136.50	22.75		
		<i>Oz - Syrup</i>	384	64		
		<i>Oz - Juice</i>	2880	480		
		<i>Gallons - Juice</i>	22.5	3.75		
		<i>Price/oz - Juice</i>	\$.047	\$.047		

Concession Products

Tortilla Chips					
	261106	Bulk Tortilla Chip	6 / 2 lb	E 1/4 B	
	261194	2 oz Yellow Rounds	60 / 2 oz	E 2/3 B	

Nacho Cheese					
	20024	Zesty Cheddar Cheese Sauce - Bag	4 / 140 oz	E	
	2002FC	Mild Cheese Sauce - Cups	48 / 3.5 oz		

Paper Nacho Trays					
	22061	#200 Paper Trays	4 / 250	Call for Pricing	

Kaiser Pickles					
	80021	Dill Pickle Slices, 1/8" Crinkle Out - Pail	1 / 5 gal	E	
	80022	Dill Pickle Slices, 1/8" Crinkle Out - Jugs	4 / 1 gal	E	

S Meets the USDA Smart Snacks In School Guidelines!









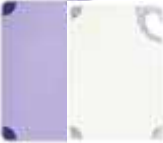

E Item is eligible for menuing as long as all meal requirements are met.

Icons for Food Items

B (Grains/Breads) F (Fruits) D (Dairy) P (Proteins) V (Vegetables)
 Items contribute to the USDA Food Buying Guide for Child Nutrition Programs



Peanut Free 	Trans-Fat Free 	Gluten Free 	Whole Grain 
---	--	---	---

Kitchenwares - Call for Pricing

	San Jamar - Carton Opener		
	754011	Red Carton Opener	1 Unit
	BB100	Boa Bag Cutter	1 Unit
	San Jamar - Cutting Boards		
	CBG1218WH	Cutting Board - White - 12x18x1/2	1 Unit
	CBG912WH	Saf T Grip Cutting Board - White - 9x12	1 Unit
	CBG912PR	Allergen Saf T Cutting Board - Purple - 9x12	1 Unit
	KLRST	Cutting Board Storage Stand	1 Unit
	San Jamar - Ice Handling		
	751700	Saf-T-Scoop & Guardian (12-16oz)	1 Unit
	San Jamar -Kevlar Sleeves		
	757516	Sleeve - 500 temp protection	1 Sleeve
	San Jamar - Kleen Pails		
	751964	Green Kleen Pail - 6qt	1Ea
	751967	Red Kleen Pail - 6qt	1Ea
	San Jamar - Mod Pans		
	7576712	1/2 Modpan with Lid - 9qt	6 Pans
	7576713	1/3 Modpan with Lid - 4qt	12 Pans
	7576714	1/4 Modpan with Lid - 4qt	12 Pans
	San Jamar - Oven Mitts		
	800FG15-BK	15" Best Guard Oven Mitt - Washable	2 Mitts
	810CM15	15" Best Guard Oven Mitt with Magnet	1 Mitt
	KT0218	17" Cool Touch Flame Oven Mitt - 535 temp protection	1 Mitt
	UCMX13BK	13" Ulti-Grip Oven Mitt - 450 temp protection	1 Mitt
	UCMX15BK	15" Ulti-Grip Oven Mitt - 450 temp protection	1 Mitt
	UCMX17BK	17" Ulti-Grip Oven Mitt - 450 temp protection	1 Mitt
	San Jamar - Pan Grabbers		
	803PG	9.5" x 11" Grabber with Strap	12 Grabbers
	823TPH	10" x 11" Grabber	12 Grabbers
	San Jamar - Pot Holders		
	802TPH	Terry Cloth 8" x 8" Holder	12 Holders
	802TF	Best Guard 8" x 8" Holder	12 Holders
	San Jamar - Wrapping Stations		
	SW1218SC	Saf-T Wrap Station with Cutter	1 Unit
	SW18	Saf-T Wrap Station - 18" Film Dispenser	1 Unit
	SWX100	Saf-T Wrap Stacking Station	1 Unit
	XSW102377	Saf-T Wrap Replacement Blades	2 Blades
	San Jamar - Ulti-Grip Hot Pads		
	750077	7" x 7"	1 Pad
	751010	10" x 10"	1 Pad

*Item numbers in purple are low stock items or special order items.

For more safety and food prep items not listed, please visit www.sanjamar.com

	Standing Frame 274-2700 Floor Stand (28"x22")	1 ea
	Hanging Frame 274-2704 Black Plastic Frame (28"x22") 274-2705 Black Metal Flip Frame (28"x22")	1 ea 1 ea

Serving Equipment

	Sterno Delivery Coolers/Warmers	
	5000 Milk Crate Kooler	1 ea
	5001 Double Milk Crate Kooler	1 ea
	5002 Medium Breakfast Kooler (holds 50 bagels)	1 ea
	5003 Large Breakfast Kooler (holds 70 bagels)	1 ea
	5005 Travel Cart (Milk Koolers & Breakfast Koolers)	1 ea

Techni-Ice, NatureSeal, & Papergoods

	Techni Ice 004 Techni Ice Reuseable Ice/Heat Pack	10 Sheets
	NatureSeal 34125 1.25lb NatureSeal 34380 3.3lb NatureSeal	1 ea 1 ea
	Can Liners Call For Pricing 61332 60 gallon, 38x60, 22 Micron	150
	Cups Call For Pricing 60022 7 oz Plastic 62802 6 oz Foam	2500 1000
	Diaper Changing Paper Call For Pricing 62773 12 1/8 x 16 3/8 Sheets	500
	Facial Tissues Call For Pricing 64230 Standard 100 / 2 Ply	1000
	Paper Towels Call For Pricing 64233 Household Roll - 85 / 2 Ply	30 / 85
	Plastic Ware Call For Pricing 13000 Spoon, Medium, White	1000
	Trays / Plates Call For Pricing 63689 9" Paper	1200

Sunkist Sectionizer & NatureSeal

Cut your fruits and veggies with
a **Sunkist** Fruit Sectionizer



Equipment

Item #	Mfg Item#	Item Description
732-100	S-100	Sunkist Blank Sectionizer (No blade /plunger)
732-102	S-102	Sunkist Orange Complete Sectionizer (6 wedge)
732-106	S-106	Sunkist Apple Complete Sectionizer (6+core)
732-103	S-103	Sunkist 6 Slice Complete Sectionizer (6 slice)
732-200	S-200	Sunkist Junior Sectionizer (No Blade)
732-31	S-31	Sunkist Production Stand (raises stand for pans)

Optional Blades and Plungers

Item #	Mfg Item#	Item Description
732-3	S-3B	6 Section Blade-Cup & Cover (Multiple)
732-4	S-4B	6 Slice Blade-Cup & Cover (Hard Fruit & Veggie)
732-5	S-5	4 Wedge Blade-Cup & Cover (Multiple)
732-9	S-9	6 Section Plunger (Multiple)
732-10	S-10	6 Slice Plunger (Hard Fruit & Veggie)
732-20	S-20	10 Wedge Blade-Cup & Cover (Multiple)**
732-21	S-21	10 Section Plunger**
732-29	S-29B	8 Section Blade-Cup & Cover (Multiple)**
732-30	S-30B	2 Halves (Scored in 3 wedges each)
732-35	S-35B	2 Halves (Cuts in half)

Optional Blades and Plungers

732-32	S-32B	6 Section Blade-Cup & Cover w/Corer (Apple)
732-33	S-33	6 Section Plunger w/Corer (Apple)

****Italicized items are non-stocked items, but can be special ordered.**

Sunkist Sectionizer Exploded View & Parts

Part numbers listed below are Sunkist Item numbers. Please see bottom of page 5 for CFS corresponding item numbers.

Sunkist Sectionizer

Parts Information

Effective date November 1, 2011

- Part Number Parts Description**
- S-1 Foot Pad (set of 6)
 - S-2 Base Assembly
 - S-3B Blade Cup w/cover (6 wedge) (fits S-9)
 - S-4B Blade Cup w/cover (6 slice) (fits S-10)
 - S-5B Blade Cup w/cover (4 wedge) (fits S-9)
 - S-6 Wedger Cup cover (sold w/S-3, S-5, S-29, S-30, S-32, S-35)
 - S-7 Slicer Cup cover (sold w/S-4)
 - S-8 Outer Shell
 - S-8D Pin & Thread Assembly
 - S-9 Plunger Wedger (fits parts S-3, S-5, S-29, S-30, S-35)
 - S-10 Plunger Slicer (fits S-4)
 - S-11 Crossbar Assembly
 - S-11C Brass Knob
 - S-11D Brass Stud
 - S-12 Back Screw #8 x 1/2" (set of 8)
 - S-13 Back Cover
 - S-14 Spring Pin (set of 2)
 - S-15 7 Slice Blade Cup w/cover (fits S-16)
 - S-16 Plunger Tomato Slicer (fits part S-15)
 - S-17 Tomato Set (S-15 & S-16)
 - S-19 Wedger Cup Cover (10 wedge) (sold w/S-20)
 - S-20B Blade Cup w/cover (10 wedge) (fits S-21)
 - S-21 Plunger (fits S-20)
 - S-22 10 Wedge Set (S-20 & S-21)
 - S-23 Gears & Shaft Set
 - S-24 Base Side Screw 6-32 x 1 1/2" (set of 10)
 - S-25 Plastic Shaft Cover
 - S-26 Handle
 - S-27 Knob
 - S-28 Bottom Screw #8 x 1/2" (set of 4)
 - S-29B Blade Cup w/cover (8 wedge) (fits S-9)
 - S-30B Blade Cup w/cover (3-in-1) (fits S-9)
 - S-31 Plastic Production Stand (see below)
 - S-32B Apple Corer Cup (fits S-33)
 - S-33 Apple Plunger (fits S-32)
 - S-34 Apple Corer Set (S-32 & S-33)
 - S-35B Blade Cup w/cover (single) (fits S-9)

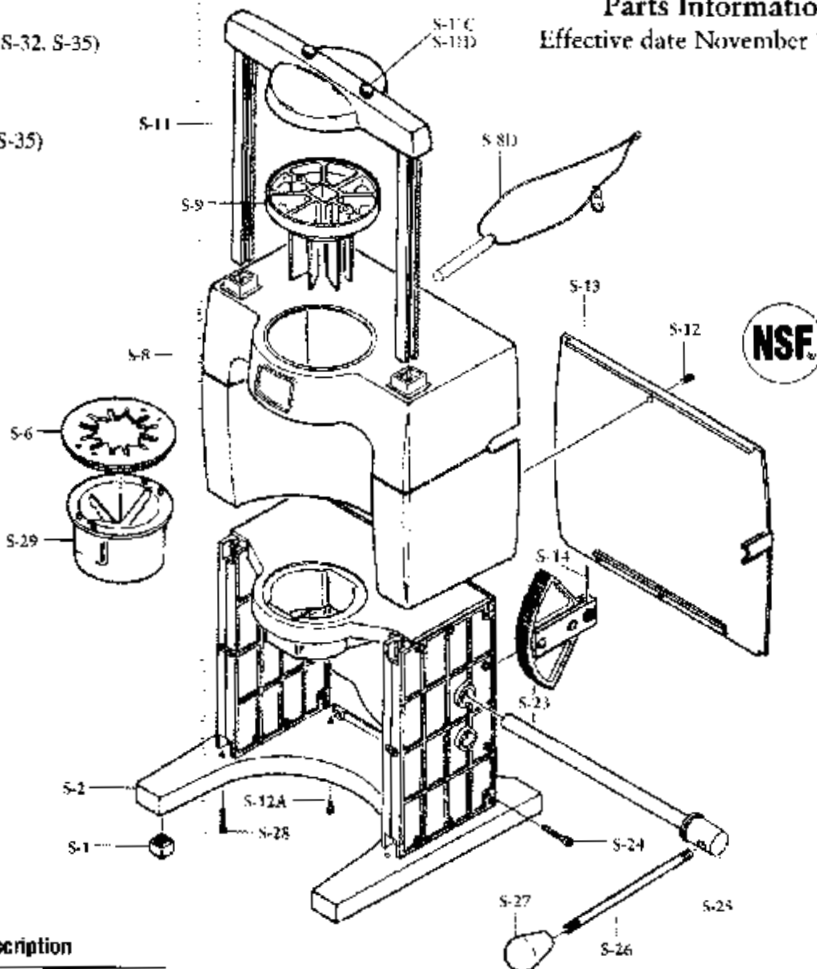

Complete Sectionizer Model #	Blade Cup Style	Description
S-101		4 evenly spaced and cut wedges.
S-102		6 evenly spaced and cut wedges.
S-103		6 slices 5/16" thick. Must use plunger S-10.
S-104		8 evenly spaced and cut wedges.
S-105		2 halves scored in 3 wedges each (for school foodservice).
S-106		6 evenly spaced and cut wedges with center core removed. Must use plunger #33.
S-107		Cuts fruit & vegetables in half.
S-109		7 evenly spaced slices. Must use plunger S-16.
S-110		10 evenly spaced and cut wedges.

Specifications

Safe...Listed by NSF International®.

Overall Dimensions15 1/2" high, 15 1/4" wide, 13 1/8" deep

Net Weight13 pounds

Shipping Weight15 pounds

Cube2.32

Carton Size17 1/2" L x 13 1/2" W x 17 1/2" H



A sturdy plastic stand that allows serving pans (not included) to pass under the sectionizer for greater production flexibility.

Overall Dimensions5 1/4" high, 14 1/2" wide

Shipping Weight2 pounds, 3 oz.

Reduce prep and serving time with **Ekon-O-Pac** and **Sunkist!**



Ekon-O-Pac packaging systems

each system contains a black bag stand & heavy duty bag sealer

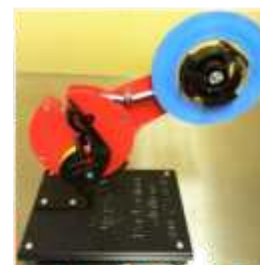

Equipment

Item #	Item Description
14000Y	Complete System (Stand & Sealer)
14001	Black Bag Stand
14002Y	Heavy Duty Bag Sealer

Bag Sealing Tape (Cold Bags Only)

Item #	Item Description	Qty
14021	Tape - White	2500
14022	Tape - Light Blue	2500
14023	Tape - Green	2500
14024	Tape - Yellow	2500
14025	Tape - Red	2500
14026	Tape - Orange	2500

Bag Sealing Tape (Hot Bags Only)

14020	Tape - Clear	1500
-------	--------------	------

Recommended & Stocked Bags

Item #	Bag Size	Qty	Uses
14459	4.5x9.5	5000	½ - 1 Cup Fruit/Veggie
14576	5x7	5000	½ - 1 Cup Fruit/Veggie
14686	6x8.75	5000	Whole Orange/Apple
14750	7.5x10	5000	Lg Melon Wedge/Hoagie Roll
14892	8x9x2.5	3000	Sm Meal Sack, Leftovers
14916	9x12x2.75	3000	Lg Breakfast / Lunch Sack
14101	10x15	3000	XL Breakfast / Lunch Sack

Ovenable, Vented Hot Bags

15788	7x9	5000	Large Sandwich Bag
-------	-----	------	--------------------

Mid-Temp, Vented Hot Bags

15688	6x9	5000	5" Bun Sandwich
-------	-----	------	-----------------

MicroPerf Hot Bags -Browns/cooks product in the bag

16696	6x9	5000	Chicken, Pizza
16796	7x9	5000	Hamburger, Chicken Sandwich

Ovenable and MidTemp Bags available by special order...with 4 week lead. Ask Sales Person about sizes and pricing.

PARTS LIST BELOW

Ekon-O-Pac Parts

Flat Spring
Item #: 2200-28

Index Wheel
Item #: 2200-30

Tape Wheel
Item #: 2200-40

Coil Spring
Item #: 2200-5

Tape Knife
Item #: 2200-16

Coil Spring
Item #: 2200-5Y

All parts below are in a single part kit. Kit includes tape knife, index wheel, and coil spring.

Old Style Red Ekon-O-Pac Bagging System

Not Pictured:
Trimmer Blade (5 pk)
Item #: 14005
Same Item number for old & new style.
Item # 2200-R - Yellow Rebuild Kit
Item # 2200-WRB - Yellow Tape Wheel Rebuild Kit

Ask your Commercial Foods Sales Rep about in-services for continuing education credits that meet the Federal Guidelines.

Ekon-O-Pac Systems and Bags

* Items highlighted in yellow are stock items. (All other items may be stocked later)

ECON-O-PAC, INC. BAG STAND SYSTEM

CFS Product #:	Econ-O-Pac, Inc. #:		Pack	Recommended Use
14000Y	EPAC 4 System	EPAC 4 System	each	Bag Sealer & Stand (Complete Unit)
14001	EPAC 4 Bag Stand	EPAC 4 Bag Stand	each	Bag Stand Only.
14002Y	EPAC 4 Bag Sealer	EPAC 4 Bag Sealer	each	Bag Sealer Only.

Cold Bags

Product No:		Bag Size	Pack	Recommended Use
14459	CD4595NV	4.5 x 9.5	5000	2-1/2" to 4" Cookie, sliced jicama, cut fresh fruit, cut vegetables, boiled egg & cheese / cracker packet.
14576	CD57NV	5.5 x 7	5000	4" Cookie, cut fresh fruit & vegetables, melon, brownies, hamburger set up, dinner roll, salad dressing packet with crackers.
14686	CD68NV	6 x 8.75	5000	Sandwich on 4" bun, melon wedge, cut fruit & vegetables, 2 slice bread flat sandwich, dinner roll.
14750	CD7510NV	7.5 x 10	5000	2 full sandwiches, multiple items in bag, break bag including yogurt, fruit, cold cereal.
14896	CD89NV	8 x 9	5000	Large bagel & cream cheese, ex-large cookie, large slice of jerky, Large croissant sandwich or club sandwich.
14892	SB8925NV	8 x 9 x 2.5	3000	Triangle sandwich bag. Use our backing board and this bag to bag and seal attractive sandwich.
14916	BB91GNV	9 x 12 x 2.75	3000	Breakfast bag. Use of breakfast or meal replacement also for Vending application.
14101	CD1015NV	10 x 15	3000	Sack lunch, breakfast in the classroom holds entire replacement meal, tape seal for sanitation and security.

EPAC OVENABLE VENTED HOT BAGS

15688	HB68V	6 x 9	5000	Large hoagie sandwich.
15788	HB78V	7 x 9	5000	5" bun type sandwich, hamburger, cheeseburger, etc. tape seal.

Foil trays are recommended due to higher temperature capabilities.

EPAC OVENABLE MICRO PERF BAGS

MICRO PERF BROWNING AND CRISPING IN THE BAG. Bag frozen, store in freezer. Prior to serving single layer on sheet pan heat in oven at up to 450 F

16696	HB68MP	6 x 9	5000	Chicken nuggets, tator tots, fries, etc. tape seal
16796	HB78MP	7 x 9	5000	Larger portion than above, 6" round pizza, pizza slice.

Ovenable Sealing Tape

14020	1402 H	Clear	1500	Clear only, Temp to 400 degree.
-------	--------	-------	------	---------------------------------

Epac Tape

Product No:		Color	Seals/roll	Recommended Use
14021	1402W	White	2500	1 roll seals 2500 bags.
14022	1402B	Light Blue	2500	1 roll seals 2500 bags.
14023	1402G	Green	2500	1 roll seals 2500 bags.
14024	1402Y	Yellow	2500	1 roll seals 2500 bags.
14025	1402R	Red	2500	1 roll seals 2500 bags.
14026	1402O	Orange-Tan	2500	1 roll seals 2500 bags.

Fruit Sectionizers

Apple and Orange Combined Unit Price

732-200	Sunkist Sectionizer Jr.		each	Sectionizer Jr
732-106	Sunkist S106 Apple	Sunkist S106 Apple	each	Sectionizer Complete: (Includes: Wedge Plunger S-33 & Blade-Cup & Cover S-32) produces - 6 evenly spaced and cut wedges with center core removed.
732-9	6 Section Wedge Plunger (Orange)	S-9	each	6-Section Wedge Plunger for use with S-3B (#732-3)
732-3	6 Section Blade-Cup & Cover (Orange)	S-3B	each	6-Section (Orange) Blade-Cup & Cover for use with S-9 (#732-9)
732-10	6-Slice Plunger	S-16	each	6-Slice Wedge Plunger for use with S-15 (#732-4)
732-4	6-Blade Blade-Cup & Cover	S-15	each	6-Slice Blade-Cup & Cover for use with S-16 (#732-10)
732-30	3-in-1 Blade-Cup	S-30B	each	2 Halves Scored in 3 Wedges Each, use with 732-9 Plunger
732-35	Single Blade Cup	S-35B	each	Cuts fruits and vegetables in half, use with 732-9 Plunger

Item # 272-6215

What makes a Healthy Breakfast Tray

Item # 272-6217

What makes a Healthy Breakfast Dots

Item # 272-6216

What makes a Healthy Breakfast Tray
"Chalk Board" style

Item # 272-6215



Item # 272-6217



Item # 272-6216

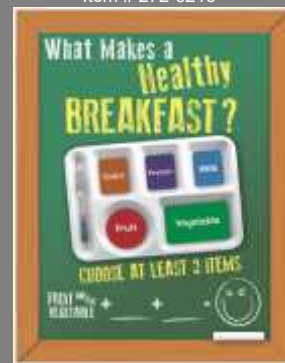

Item # 272-6209-1



Item # 272-6209



Item # 272-6213-1



Item # 272-6209-1 (landscape)

What makes a Healthy Lunch Tray

Item # 272-6209 (portrait)

What makes a Healthy Lunch Tray

Item # 272-6213-1

Offer vs Serve

Item # 272-6208

What makes a Healthy Lunch Dots

Item # 272-6211

What makes a Healthy Lunch Tray
"Chalk Board" style

Item # 272-6208



Item # 272-6211



Item # 272-6203

My Plate

Item # 272-6210

Make a Healthy Plate

Item # 272-6203



Item # 272-6210



DRY
ERASE
BOARDS

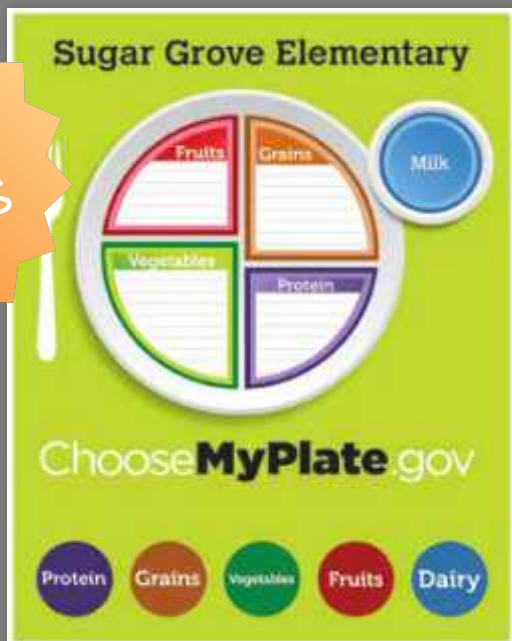

MENU
BOARD
& MENU
STRIPS

NEW!

Dry Erase Menu Strips

- Chicken Alfredo
- Turkey Burger
- Fruit Cocktail
- Green Beans
- Spring Salad
- Apple



Slide In menu strips available via direct print, vinyl print, wet erase. Magnetic menu strips are also available.

CONTACT YOUR

SALES REPRESENTATIVE
TODAY!

(800)283.7437

signs@commercialfoodsystems.com

fax **(317)924.3086**

COMMERCIAL
FOOD SYSTEMS, INC.

